



jaypro *sports*

2017/18
ALL SPORT

Field/Facility Equipment



Designed To Perform. Manufactured To Last.™





Scoreboards

Ceiling Suspended Basketball Backstops



WallGuard Wall Padding



Overhead Volleyball System

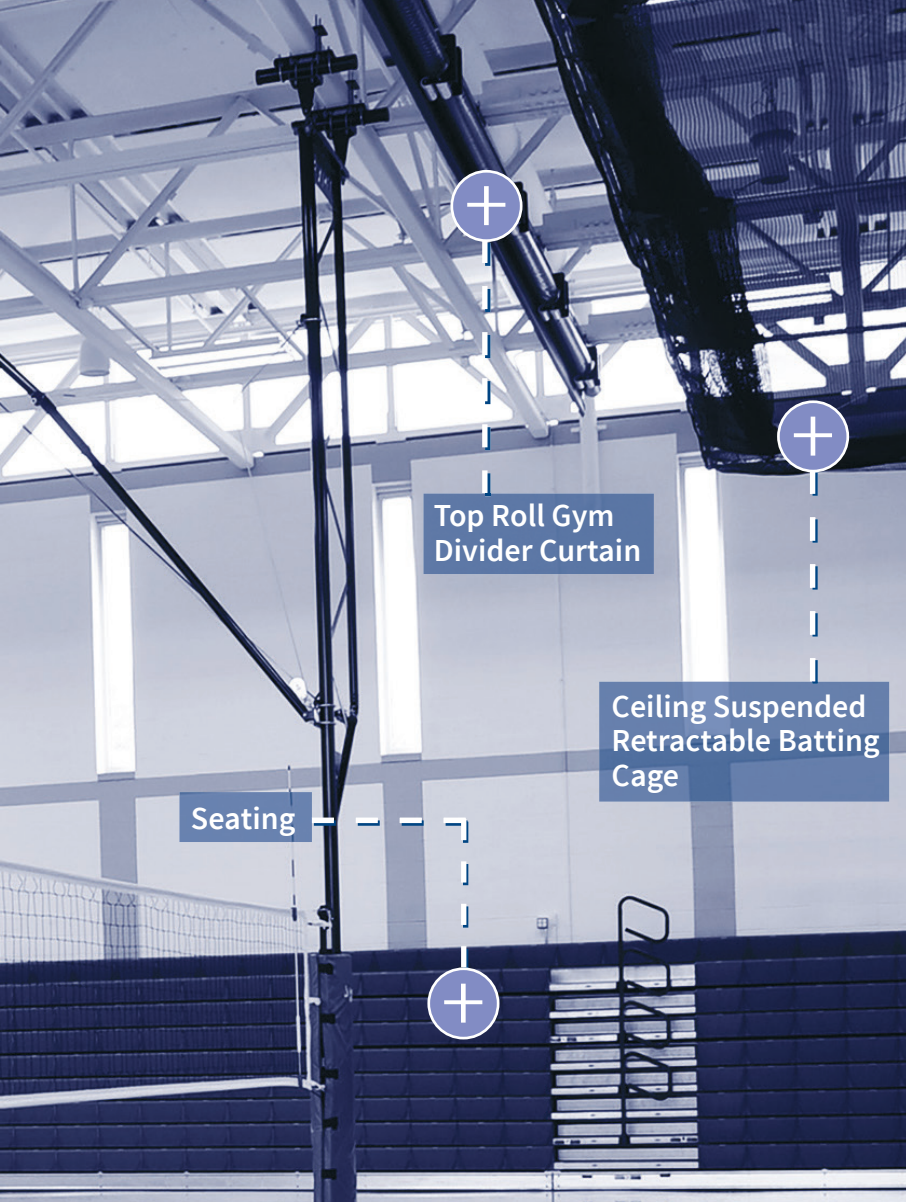

Top Roll Gym
Divider Curtain

Ceiling Suspended
Retractable Batting
Cage

Seating

CATALOG ICONS



NEW PRODUCT
Added to the catalog
for 2017



BEST SELLER
The best seller in our
product line

FR TRUCK FREIGHT
Product ships by Truck

PC POWDER COATED
Product is powder coated
for extra durability

▶ VIDEO
Visit our website to see
this product in action

12Y WARRANTY
Number of years each
product is warranteed

X JAYPRO EXCLUSIVE
A feature or product
developed exclusively
by Jaypro

AS ALL SURFACE
FRIENDLY
Indoor, Outdoor, Turf,
Grass or Dirt

★ MADE IN THE U.S.A.
Product made in America

ROYAL BLUE

RED

COLOR CHOICES FROM CHARTS
Colors displayed may not be an exact match

Featured Products 2-3
New and Innovative Products



Volleyball 4-19
*Indoor & Outdoor Systems, Floor Sleeves, Nets,
Referee Stands & Training Equipment*



Soccer 20-43
*Goals, Indoor/Outdoor, Youth, Futsal, Nets,
Rebounders, Anchors & Combo Goals*



Football 44-51
*Goal Posts, Post Pads, Equipment Carts,
Training Aids, Field & Turf Accessories*



Lacrosse/Field Hockey 52-55
*Official Goals, Practice Goals,
Training Aids & Nets*



Baseball/Softball 56-75
*Batting Cages, Pitching Screens, Bases,
Field Mats & Covers, Mounds & Foul Poles*



Field Marking 76-79
*Dry, Wet & Combo Markers,
Line Layout & Marking Systems*



Scoreboards/Sports Training 80-81
Scoreboards & Sports Training Machines



Basketball 82-93
*Outdoor Units, Hoop Rejuvenator, Post
Padding, Backboards, Goals & Edge Padding*



Indoor Gymnasium 94-109
*Portables, Wall Mounted Backstops, Safety Strap,
Winches, Height Adjusters, Curtains & Wall Pads*



Field Netting 110-115
*Portable Netting, Ball Stop Systems,
Perimeter Netting Systems & Discus Cage*



Ball Storage 116-119
Ball Carriers & Carts



Benches & Bleachers 120-129
*Player Benches, Scorers Table &
Standard or Preferred Bleachers*



Tennis 130-131
*Posts, Nets, Tennis Bench &
Wind Screens*



**Physical Education/
Index** 132-137
*Backboard Adapter, Game Standards,
P.E. Equipment & germninja*



New and Featured Products

Roller Assembly Kit • Page 34



Classic Club Goals • Page 29



Deluxe Official Futsal Goal • Page 30

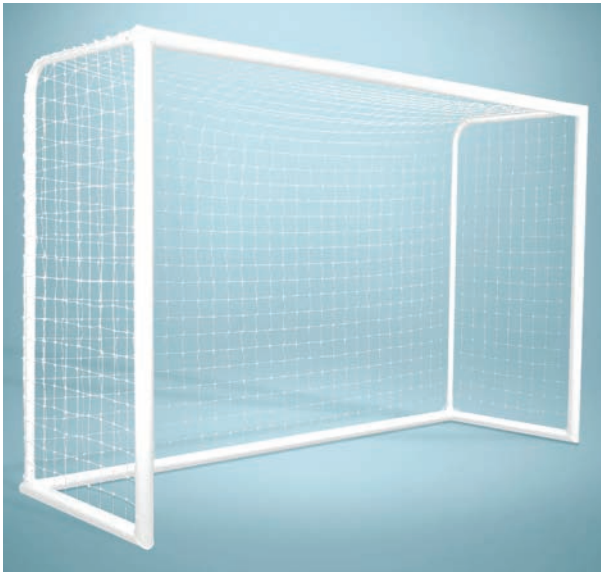

Practice Futsal Goal • Page 30



Lacrosse Goal Transport Cart • Page 52



Short Sided Pitchers Screen • Page 67



www.jaypro.com
T: 800-243-0533 F: 800-988-3363



Many Jaypro Sports products are made and assembled in the U.S.A.

★ Look for the gray star icon to identify these products

Deluxe Pickleball Posts • Page 130

Recreational Basketball Units • Page 83



Hoses and Nozzles • Page 75



Jaypro Sports now offers custom graphics on pole padding, wall padding, net tapes and more.

See pages 108-109 to learn more.



www.jaypro.com
T: 800-243-0533

F: 800-988-3363



POWERLite™ Volleyball System Package

- > Powerlite™ Volleyball System (PVB-6500 or PVB-7000)
- > Folding Referee Stand (VRS-6000)
- > Referee Stand Padding (VRS-60P)
- > Single Net Keeper (VNK11)
- > Hammock Drill Cart (HSVBC24)
- > Cable/Buckle Covers (VCC-12)
- > Custom Lettering (PVL-39) on Upright Padding

PVB-7PKG

3½" System \$4,429 package



PVB-6PKG

3" System \$4,539 package



POWERLite™ Deluxe Volleyball System Package

- > Powerlite™ Volleyball System (PVB-6500 or PVB-7000)
- > Folding Referee Stand (VRS-6000)
- > Referee Stand Padding (VRS-60P)
- > Single Net Keeper (VNK11)
- > Hammock Drill Cart (HSVBC24)
- > Cable/Buckle Covers (VCC-12)
- > Standard Volleyball Equipment Carrier (EC-500)
- > The Spiker (TS612)
- > Custom Lettering (PVL-39) on Upright Padding

PVB-7PKGDX

3½" System \$4,919 package



PVB-6PKGDX

3" System \$5,019 package



www.jaypro.com
T: 800-243-0533 F: 800-988-3363

T: 800-243-0533
F: 800-988-3363



FEATHERLite™ Volleyball System Package



- > Featherlite™ Volleyball System (PVB-4500 or PVB-5000)
- > Folding Referee Stand (VRS-6000)
- > Referee Stand Padding (VRS-60P)
- > Single Net Keeper (VNK11)
- > Hammock Drill Cart (HSVBC24)
- > Cable/Buckle Covers (VCC-12)
- > Custom Lettering (PVL-39) on Upright Padding

PVB-5PKG

3½" System \$3,999 package



PVB-4PKG

3" System \$4,099 package



FEATHERLite™ Deluxe Volleyball System Package



- > Featherlite™ Volleyball System (PVB-4500 or PVB-5000)
- > Folding Referee Stand (VRS-6000)
- > Referee Stand Padding (VRS-60P)
- > Single Net Keeper (VNK11)
- > Hammock Drill Cart (HSVBC24)
- > Cable/Buckle Covers (VCC-12)
- > Standard Volleyball Equipment Carrier (EC-500)
- > The Spiker (TS612)
- > Custom Lettering (PVL-39) on Upright Padding

PVB-5PKGDX

3½" System \$4,479 package



PVB-4PKGDX

3" System \$4,589 package



www.jaypro.com
T: 800-243-0533

F: 800-988-3363



3" Adapter for
PVB-6500

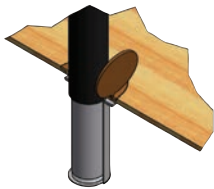

System Features

Infinite
Height



Recessed
Pulley Wheel



Worm Drive
Winch



Engraved
Height Markings



POWERLite™

a **jaypro sports** product

3½" Powerlite™ Volleyball System

- > NCAA, NFHS and USVBA compliant
- > Designed for international, collegiate and advanced high school level play
- > Infinite height adjustment range from 6'6" to 8'2"
- > Lightweight aluminum uprights fit 3½" dia floor sleeves
- > Engraved height markers on uprights
- > Recessed polymer pulley wheel and worm drive winch
- > Flex Net™ (PVBN-6), antennae and upright padding included
- > See chart on page 13 for vinyl colors (specify when ordering)
- > Available as complete system, uprights only or center package
- > Center package includes center pole with winch, Flex Net™ and upright padding (purchase in addition to system for a two court set-up)

PVB-7000 Complete System 116 lbs
\$3,499 each **FR** **10Y** **3Y** **1Y** **X**

PVB-70U Uprights Only (includes winch) 82 lbs
\$2,499 pair **10Y** **3Y** **★**

PVBC-700 Center Package 62 lbs
\$2,449 each **FR** **10Y** **3Y** **1Y** **X**

3" Powerlite™ Volleyball System

- > NCAA, NFHS and USVBA compliant
- > Designed for international, collegiate and advanced high school level play
- > Infinite height adjustment range from 6'6" to 8'2"
- > Lightweight aluminum uprights fit 3" dia floor sleeves and have a factory installed adapter
- > Engraved height markers on uprights
- > Recessed polymer pulley wheel and worm drive winch
- > Flex Net™ (PVBN-6), antennae and upright padding included
- > See chart on page 13 for vinyl colors (specify when ordering)
- > Available as complete system, uprights only or center package
- > Center package includes center pole with winch, Flex Net™ and upright padding (purchase in addition to system for a two court set-up)

PVB-6500 Complete System 117 lbs
\$3,624 each **FR** **10Y** **3Y** **1Y** **X**

PVB-65U Uprights Only (includes winch) 83 lbs
\$2,599 pair **10Y** **3Y** **★**

PVBC-650 Center Package 63 lbs
\$2,549 each **FR** **10Y** **3Y** **1Y** **X**

Complete System

Uprights
with Winch



Patented
Flex Net



Upright
Padding



Antennae



FEATHERLite™

a **jaypro sports** product

3½" Featherlite™ Volleyball System

- > NCAA, NFHS and USVBA compliant
- > Designed for collegiate and high school level play
- > 16 pin-stop height adjustment range from 6'6" to 8'2"
- > Lightweight aluminum uprights fit 3½" dia floor sleeves
- > Engraved height markers on uprights
- > Recessed polymer pulley wheel and worm drive winch
- > Flex Net™ (PVBN-6), antennae and upright padding included
- > See chart on page 13 for vinyl colors (specify when ordering)
- > Available as complete system, uprights only or center package
- > Center package includes center pole with winch, Flex Net™ and upright padding (purchase in addition to system for a two court set-up)



PVB-5000	Complete System	115 lbs
	\$2,987 each	FR ● 10Y 3Y 1Y X
PVB-51U	Uprights Only (includes winch)	70 lbs
	\$1,949 pair	● 10Y 3Y ★
PVBC-500	Center Package	60 lbs
	\$1,849 each	FR ● 10Y 3Y 1Y X

3" Featherlite™ Volleyball System

- > NCAA, NFHS and USVBA compliant
- > Designed for collegiate and high school level play
- > 16 pin-stop height adjustment range from 6'6" to 8'2"
- > Lightweight aluminum uprights fit 3" dia floor sleeves and have a factory installed adapter
- > Engraved height markers on uprights
- > Recessed polymer pulley wheel and worm drive winch
- > Flex Net™ (PVBN-6), antennae and upright padding included
- > See chart on page 13 for vinyl colors (specify when ordering)
- > Available as complete system, uprights only or center package
- > Center package includes center pole with winch, Flex Net™ and upright padding (purchase in addition to system for a two court set-up)

PVB-4500	Complete System	115 lbs
	\$3,112 each	FR ● 10Y 3Y 1Y X
PVB-45U	Uprights Only (includes winch)	71 lbs
	\$2,049 pair	● 10Y 3Y ★
PVBC-450	Center Package	56 lbs
	\$1,949 each	FR ● 10Y 3Y 1Y X

3" Adapter for PVB-4500

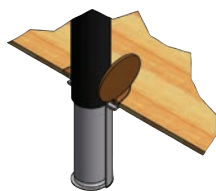

System Features



Complete System



www.jaypro.com
T: 800-243-0533

F: 800-988-3363

LADYPRO CARBON™

LadyPro Carbon™ Volleyball System

- > Fabricated from state-of-the-art carbon composite material
- > Carbon uprights have the rigidity of steel and are significantly lighter in weight than aluminum
- > Available in 3" or 3½" dia to fit conventional floor sleeves
- > Uprights are in fixed women's height (7' 4½")
- > Adjustable feet have up to 3" of fine tuning
- > Recessed polymer pulley wheel and worm drive winch
- > Flex Net™ (PVBN-6), antennae and upright padding included
- > See chart on page 13 for vinyl colors (specify when ordering)
- > Available as complete system or uprights only
- > Uprights Only package includes winch (net and padding sold separately)

PVB-8000	3½" Complete System	74 lbs	\$4,295 system	FR	●●●	3Y	1Y
PVB-80U	3½" Uprights Only (includes winch)	40 lbs	\$3,399 pair	FR	●●●	3Y	★
PVB-8500	3" Complete System	77 lbs	\$4,295 system	FR	●●●	3Y	1Y
PVB-85U	3" Uprights Only (includes winch)	43 lbs	\$3,449 pair	FR	●●●	3Y	★

CARBON ULTRALITE™

Carbon Ultralite™ Volleyball System

- > Fabricated from state-of-the-art carbon composite material
- > Carbon uprights have the rigidity of steel and are significantly lighter in weight than aluminum
- > Available in 3" or 3½" dia to fit conventional floor sleeves
- > Uprights have telescoping feature with height adjustment range (from intramurals to men's competition)
- > Adjustable feet have up to 3" of fine tuning
- > Recessed polymer pulley wheel and worm drive winch
- > Flex Net™ (PVBN-6), antennae and upright padding included
- > See chart on page 13 for vinyl colors (specify when ordering)
- > Available as complete system or uprights only
- > Uprights Only package includes winch (net and padding sold separately)

PVB-9000	3½" Complete System	78 lbs	\$4,350 system	FR	●●●	3Y	1Y
PVB-90U	3½" Uprights Only (includes winch)	44 lbs	\$3,599 pair	FR	●●●	3Y	★
PVB-9500	3" Complete System	81 lbs	\$4,350 system	FR	●●●	3Y	1Y
PVB-95U	3" Uprights Only (includes winch)	47 lbs	\$3,699 pair	FR	●●●	3Y	★



PVB-8000

PVB-9000

Multi-Purpose Net System

- > 3½" OD anodized aluminum uprights
- > Designed for high school, intramural and recreational competition level play
- > Adjustable infinite height sliding collars convert from competition volleyball system to badminton or tennis systems
- > Fits 3½" dia floor sleeves
- > Available as complete system, uprights only or center package
- > Complete system includes uprights with worm drive winch, net, pads and antennae
- > See chart on page 13 for vinyl colors (specify when ordering)
- > Center package includes center pole with winch, net and upright padding (purchase in addition to system for a two court set-up)

PVB-1350	Complete System	166 lbs	\$2,199 system	FR	10Y	1Y
PVB-13U	Uprights Only (includes winch)	83 lbs	\$1,529 pair	FR	10Y	★
PVBC-130	Center Package	51 lbs	\$1,349 package	FR	10Y	1Y
TPV-13	Tennis Net - 36'L x 42"H	6 lbs	\$189 each			1Y



Competition Badminton System

- > 2½" OD steel uprights with fixed net height
- > Designed for high school, intramural and recreational competition level play
- > Badminton net (30"W x 21'L) sold separately
- > Floor sleeves/covers (2¾" ID x 10"D) available in brass or chrome options sold separately

BSO-2U	Badminton System	47 lbs	\$569 pair	●●●	3Y	★
BND-1	Badminton Net	5 lbs	\$52 each			1Y
BSO-2G	Floor Sleeve & Cover (Brass) 23 lbs	\$349 pair				3Y
BSO-2G-CP	Floor Sleeve & Cover (Chrome) 23 lbs	\$349 pair				3Y



Steel Collegiate Net System

- > Designed for international, collegiate and high school level play
- > 3½" OD steel uprights with 16 pin-stop height adjustment range from 6'6" to 8'2"
- > Fits 3½" dia floor sleeves
- > Engraved height markers on uprights
- > Recessed polymer pulley wheel and worm drive winch
- > Flex Net™ (PVBN-6), antennae and upright padding included
- > See chart on page 13 for vinyl colors (specify when ordering)
- > Available as complete system, uprights only or center package
- > Center package includes center pole with winch, Flex Net™ and upright padding (purchase in addition to system for a two court set-up)

PVB-1500 Complete System
152 lbs \$2,787 system
FR ● 3Y 1Y

PVB-150U Uprights Only (includes winch)
118 lbs \$1,679 pair
FR ● 3Y ★

PVBC-150 Center Package
80 lbs \$1,579 package
FR ● 3Y 1Y

Classic Steel Collegiate Net System

- > Designed for international, collegiate and high school level play
- > 3" OD steel uprights with 16 pin-stop height adjustment range from 6'6" to 8'2"
- > Fits 3" dia floor sleeves
- > Engraved height markers on uprights
- > Recessed pulley wheel and worm drive winch
- > Flex Net™ (PVBN-6), antennae and upright padding included
- > See chart on page 13 for vinyl colors (specify when ordering)
- > Available as complete system, uprights only or center package
- > Center package includes center pole with winch, Flex Net™ and upright padding (purchase in addition to system for a two court set-up)

PVB-3000 Complete System
157 lbs \$2,635 system
FR ● 3Y 1Y

PVB-30U Uprights Only (includes winch)
123 lbs \$1,599 pair
FR ● 3Y ★

PVBC-300 Center Package
93 lbs \$1,519 package
FR ● 3Y 1Y

Second Floor Competition Net System

Ideal for use where floor sleeves are impractical.

- > NCAA, NFHS and USVBA compliant
- > Designed for collegiate and high school level play
- > Top level performance without the use of cables or wires
- > 3½" OD aluminum uprights with worm drive winch
- > Choice between infinite height adjustment or 16 pin-stop height adjustment (range of 6'6" to 8'2")
- > Hand knobs secure steel T-base to anchors (sold separately) in floor for added safety and security
- > Flex Net™ (PVBN-6), antennae and standard/base padding included
- > See chart on page 13 for vinyl colors (specify when ordering)
- > Available as complete system, uprights only or center package
- > Center package includes center pole with winch, Flex Net™ and upright padding (purchase in addition to system for a two court set-up)

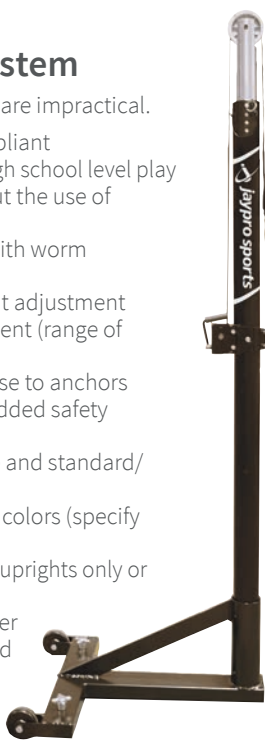

PVB-2700 Infinite Height Adjustment

PVB-2700 Complete System 202 lbs
\$3,725 system FR ● 3Y 1Y

PVB-270UB Uprights Only (includes winch) 155 lbs
\$2,900 pair FR ● 3Y ★

PVBC-270 Center Package
\$2,800 package FR ● 3Y 1Y

PVB-2500 Pin Stop Height Adjustment

PVB-2500 Complete System 192 lbs
\$2,719 system FR ● 3Y 1Y

PVB-250UB Uprights Only (includes winch) 145 lbs
\$1,999 pair FR ● 3Y ★

PVBC-250 Center Package
\$1,939 package FR ● 3Y 1Y

Replacement Base Pad

Ideal only for Second Floor Competition Net Systems (PVB-2700 or PVB-2500).

- > Standard base pad
- > See chart on page 13 for vinyl colors (specify when ordering)

PVB-25P \$319 pair
3Y ★



Volleyball Nets

FLEXNET™ a jaypro sports product

Flex Net™

Ideal for volleyball uprights set between 35' and 37'.



- > Designed for international, collegiate, and high school competition play
- > Eliminates cumbersome cables by replacing them with heavy-duty woven nylon top and bottom bands
- > Headband attaches directly to winch leader strap for superb net tension
- > Adjustable straps attach to existing bottom band for additional length (not included with all nets)

Due to varying court sizes, the net body may not match your court width.



Item	For Uprights set between	Net Size	4' Strap Included	Price
Flex Net™				
PVBN-6	35' - 37'	32'L x 39"H	No	\$479 each
Alternate Flex Net™ Sizes				
PVBN-628	30' - 32'	28'L x 39"H	No	\$479 each
PVBN-628ADJ	32' - 35'	28'L x 39"H	Yes	\$479 each
PVBN-6ADJ	37' - 40'	32'L x 39"H	Yes	\$509 each

Flex Net™ (with Adapter Cord)

Compatible with most manufacturer's systems such as Porter, Senoh, Bison, MacGregor, Stackhouse, Schelde or other similar volleyball systems.

- > Adapter cord connects existing winch and anchor upright to top of Flex Net™
- > 1/4" dia anchor cord and lips included
- > Note: Anchor cord should be cut to length in the field to adapt to the specific volleyball system

PVBN-6AK 14 lbs \$509 each

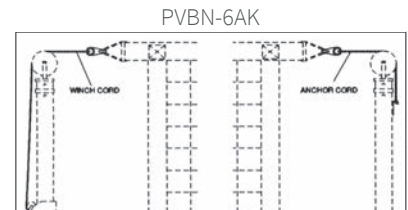

Flex Net™ (with Adapter Strap)

Compatible with Shelde or other similar volleyball systems.

- > 2" wide adapter strap "bridges" top of Flex Net™ to the anchor upright

PVBN-6J 13 lbs \$509 each

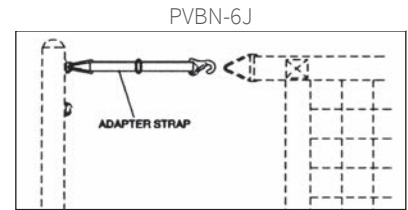

Collegiate Net

PVBN-3 32'L x 39"H
13 lbs \$229 each

Volleyball Net

VBD-6 32'L x 36"H
(2.5mm poly net with rope cable)
4 lbs \$83 each

Volleyball Net

VBN-32 32'L x 36"H
(nylon net with rope cable)
4 lbs \$92 each



Volleyball Net

VBD-3 32'L x 36"H
(2.5mm poly net with steel cable)
5 lbs \$89 each



Badminton Net

BND-1 21'L x 30"H (lightweight with rope cable)
5 lbs \$52 each

Tennis Net

TDP-42 42'L x 42"H (lightweight with rope cable)
7 lbs \$149 each



Custom Volleyball Net Tape

- > 3" customized vinyl tape with hook-and-loop attachment
- > Sized for 32' nets
- > Extended lead time applies
- > Contact customer service for artwork requirements and shipping options

CVNT-1 3 lbs \$399 each **1Y**



Single Net Keeper

- > Store nets neatly and securely in minimal space
- > Headband is wound clean and tangle free
- > 1½" thick-walled square steel tube construction
- > 4" non-marking swivel wheels
- > 1 storage bag included

VNK11 20 lbs
\$239 each **3Y**



Double Net Keeper

- > Store nets neatly and securely in minimal space
- > Headband is wound clean and tangle free
- > 1½" thick-walled square steel tube construction
- > 4" non-marking swivel wheels
- > 2 storage bags included

VNK22 24 lbs
\$269 each **3Y**



Triple Net Keeper

- > Store nets neatly and securely in minimal space
- > Headband is wound clean and tangle free
- > 1½" thick-walled square steel tube construction
- > 4" non-marking swivel wheels
- > 3 storage bags included

VNK33 42 lbs
\$309 each **3Y**

Net Keeper Storage Bag

- > Keeps nets, cords and cables off the floor and protected

VNKBAG 1 lb \$29 each **1Y**



Universal Antennae

- > Clamps directly to top and bottom of net
- > Attachment adjustments easily made from floor
- > Fits both 36" and 39" nets
- > 72" long and are colored red and white

VBA-80 3 lbs \$159 pair **3Y**



Antennae

- > Antennae slide into hook-and-loop attached sleeve
- > Fits both 36" and 39" nets

VBA-4 3 lbs \$109 pair **3Y**

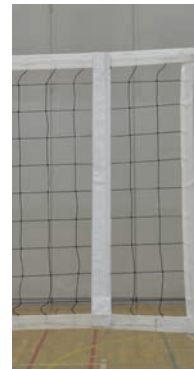

Boundary Tape

- > 2" white boundary tape with hook-and-loop closure
- > Fits both 36" and 39" nets

VA-22 1 lb \$29 pair **1Y**



Referee Stands



“MEGA REF” Folding Referee Stand

- > 1½” heavy-walled steel tube construction
- > Platform support with vinyl coated padding is 48” above floor
- > All welded frame support with non-slip foot treads
- > Protective rubber tips on legs
- > (4) 4” non-marking front wheels
- > Folds down to 30”W x 84”H x 10”D for compact storage and easy transport
- > Optional padding (VRS-60P) sold separately

VRS-8000

\$849 each

82 lbs



Folding Referee Stand

Ideal for use with any volleyball system.

- > 1½” dia steel frame construction
- > Platform support with vinyl coated padding is 48” above floor
- > Protective rubber tips on legs
- > (2) 4” non-marking front wheels
- > Folds down to 30”W x 84”H x 10”D for compact storage and easy transport
- > Optional padding (VRS-60P) sold separately

VRS-6000

\$629 each

64 lbs



Adjustable Referee Stand

Clamps onto any telescoping pole volleyball system.

- > 1½” dia steel frame construction
- > Two leg design with telescoping feet allow for height adjustment
- > Platform with vinyl coated padding
- > 2 non-marking front wheels for easy transport
- > Optional padding (VRS-30P) sold separately
- > Note: Does not fit Multi-Purpose Net System (PVB-1350) or Outdoor Competition Volleyball System (OCV-900)

VRS-3000

55 lbs

\$659 each



Clamps to pole



System & Referee Stand Padding

- PINK
- RED
- NAVY BLUE
- YELLOW
- LIGHT BLUE
- GRAY
- BLACK
- MAROON
- FOREST GREEN
- KELLY GREEN
- ROYAL BLUE
- TAN
- PURPLE
- ORANGE

Official Standard Pad

- > Meets competitive play specifications
- > 6' tall post pad attaches with hook-and-loop closure flaps
- > 2" thick polyurethane foam wrapped in 14 oz vinyl
- > Custom Lettering (PVL-39) optional
- > See chart for vinyl colors (specify when ordering)

PVB-60P 18 lbs \$509 pair 3Y ★

Custom Lettering

Get your school and/or team name in white lettering on your protector pad.

PVL-39 White Lettering 1 lb \$159 pad 3Y ★

See page 133 for our GymGlide™ Game Standard System that also can be fit with these pads



Referee Stand Padding

Fits both the "MEGA REF" Folding Referee Stand (VRS-8000) and Folding Referee Stand (VRS-6000).

- > Meets competitive play specifications
- > 1" thick polyurethane foam wrapped in 14 oz vinyl
- > See chart for vinyl colors (specify when ordering)

VRS-60P 18 lbs \$312 each 3Y ★

Fits the Adjustable Referee Stand (VRS-3000).

- > Meets competitive play specifications
- > 1" thick polyurethane foam wrapped in 14 oz vinyl
- > See chart for vinyl colors (specify when ordering)

VRS-30P 18 lbs \$312 each 3Y ★



Cable/Buckle Cover

- > Protects against exposed net cables and buckles
- > 12" long white vinyl covered foam with hook-and-loop attachment

VCC-12 4 lbs \$71 pair 3Y ★

Equipment Carriers



EC-500



EC-1000

Volleyball Equipment Carriers

Ideal for storing volleyballs, uprights, nets, pads and other equipment.

- > Heavy-duty welded steel frame powder coated blue
- > Large non-marking swivel wheels
- > Available in standard, deluxe and vertical models
- > Vinyl storage bag included with deluxe and vertical models

EC-500 Standard - 32"W x 42"L (4 pole capacity) 3Y

51 lbs \$329 each

EC-1000 Deluxe - 36"W x 48"L (6 pole capacity) 3Y

77 lbs \$499 each

VEC-1 Vertical - 35"W x 60"L (6 pole capacity) 3Y

98 lbs \$375 each



VEC-1



Floor Sleeves & Adapters



Chrome Finish



Brass Finish



Floor sleeves are generally 3", 3½" or 4". Jaypro Sports uprights are 3" or 3½". To ensure a proper fit, measure existing floor sleeves prior to selecting a system. See below for measuring instructions. Select the appropriate adapter that fits the measurements and system of choice. Reduce the inside diameter (ID) or shorten the depth of your floor sleeves with sleeve inserts shown below.

3½" Floor Sleeves and Covers

- > Heavy-duty cast brass or chrome finish construction
- > Spring loaded covers help prevent basketball dead spots
- > 3½" ID x 10" deep
- > 7½" OD lockable hinged cover plate

PVB-75S	Brass	22 lbs	\$425 pair	3Y
PVB-75S-CP	Chrome	22 lbs	\$425 pair	3Y

3" Floor Sleeves and Covers

- > Heavy-duty cast brass or chrome finish construction
- > Spring loaded covers help prevent basketball dead spots
- > 3" ID x 10" deep
- > 7½" OD lockable hinged cover plate

PVB-70S	Brass	22 lbs	\$425 pair	3Y
PVB-70S-CP	Chrome	22 lbs	\$425 pair	3Y

2¾" Floor Sleeves and Covers

- > Heavy-duty cast brass or chrome finish construction
- > Spring loaded covers help prevent basketball dead spots
- > 2¾" ID x 10" deep
- > 7½" OD lockable hinged cover plate

BSO-2G	Brass	23 lbs	\$349 pair	3Y
BSO-2G-CP	Chrome	23 lbs	\$349 pair	3Y

Cover Plate

PVB-711	Brass	7½" OD	6 lbs	\$195 each	3Y
PVB-75CVR-CP	Chrome	7½" OD	6 lbs	\$195 each	3Y
PVB-85CVR	Brass	8½" OD	7 lbs	\$205 each	3Y



Sleeve Insert/Adapter

- > Makes larger floor sleeve holes smaller
- > Specify current depth and inside diameter when ordering

Depths other than the standard 10" are special order items (non-returnable). Custom sizes (depths) may require longer lead time.

PVB-DEP	Sleeve Insert	6 lbs	\$72 each	3Y	★
SVL-3238	Modifies 3" inside diameter to 2¾" ID	12 lbs	\$75 each	3Y	★
PVB-ID	Modifies 3½" inside diameter to 3" ID	8 lbs	\$69 each	3Y	★
SVL-3528	Modifies 3½" inside diameter to 2¾" ID	14 lbs	\$82 each	3Y	★
SVL-4035	Modifies 4" inside diameter to 3½" ID	9 lbs	\$69 each	3Y	★

Sleeve Insert Measurement

To ensure proper fit of sleeve inserts, provide the following dimensions of sleeves when ordering.

1. Depth of sleeve itself
2. Depth from bottom of sleeve to playing surface
3. Inside diameter of sleeve (do not measure cover plate)

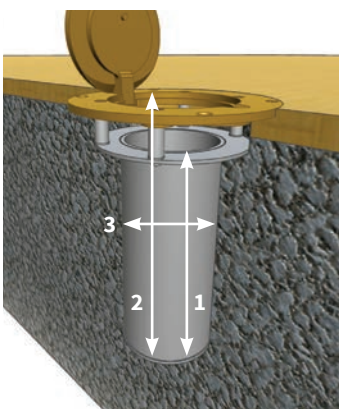

Do not measure cover plate

Measure the distance between red arrows for accurate dimension

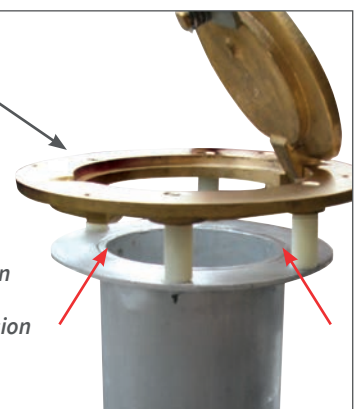

Floor Anchors

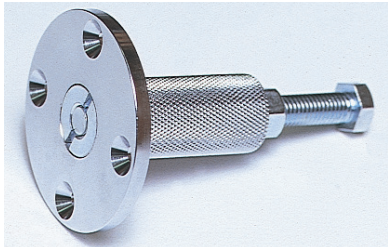

Floor Anchor (1 3/8" Cylinder)

Ideal for systems with "T" style or round bases that anchor to floor.

- > Billet steel body gives 9000 lb pullout strength
- > Designed for all floor applications except floating wood floors
- > 3/4" chrome cover with 1 3/8" wide cylinder
- > 1/2" center - 13 thread with spring loaded closure plug
- > May be used without extension bolt on wood, tile or synthetic surfaces applied directly over concrete slab or on a floating wood floor for light-duty performance
- > Includes removable cylinder in case striping occurs

FP-89 3 lbs \$145 each **3Y**

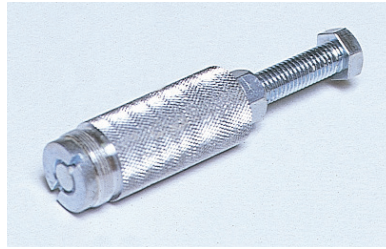

Floor Anchor (1 1/2" Cylinder)

Ideal for systems with "T" style or round bases that anchor to floor.

- > Billet steel body gives 9000 lb pullout strength
- > Designed for all floor applications except floating wood floors
- > 3/4" chrome cover with 1 1/2" wide cylinder
- > 1/2" center - 13 thread with spring loaded closure plug
- > May be used without extension bolt on wood, tile or synthetic surfaces applied directly over concrete slab or on a floating wood floor for light-duty performance
- > Includes removable cylinder in case striping occurs

FP-90 3 lbs \$125 each **3Y**



Floating Wood Floor Anchor (1 1/2" Cylinder)

Brass cover plate and anchor work independently to allow for installation into floating wood floors.

- > Billet steel body gives 9000 lb pullout strength
- > 3/4" brass cover with 1 1/2" wide cylinder
- > 1/2" center - 13 thread with spring loaded closure plug
- > Includes removable cylinder in case striping occurs

FP-100 4 lbs \$165 each **3Y**

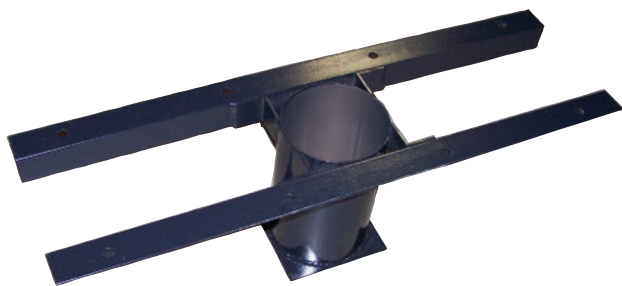

Second Floor Sleeve Bracket

- > Designed for second story installation of floor sleeves or where there is less than 12" of clearance in the sub-floor
- > Mounting hardware not included

SB-10 67 lbs \$295 each **3Y** ★

System Accessories



Wall Rack

- > Convenient storage rack
- > Heavy-duty steel rack attaches to wall
- > Holds 3 volleyball posts in upright position

VBWR-1 8 lbs \$199 each **3Y**

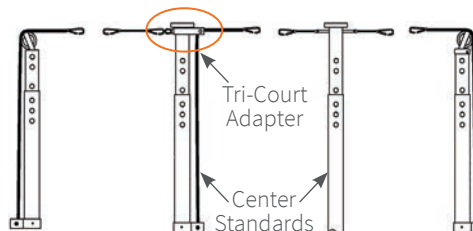

Volleyball System Tri-Court Adapter

- > Connects two center standards into a third court
- > Improves tension out of middle net
- > 3" dia x 7" tall

- > Attaches onto existing center standards
- > Compatible with many Jaypro Sports volleyball systems

PVB-303CAK

PVB-3000 System 6 lbs \$139 each **3Y**

PVB-35TCA

PVB-7000, 6500, 5000, 4500 and 1500 Systems 6 lbs \$139 each **3Y**



Equipment Carts



Hammock Drill Cart

- > Holds up to 24 balls
- > Low profile making it easier to turn, reach and spike
- > Durable steel frame is collapsible for easy storage
- > Nylon carry bag with shoulder strap included
- > Dimensions: 22"W x 48"L x 40"H x 12"D

HSVBC24 21 lbs \$149 each **3Y**

See pages 116-119
for our line of Ball
Storage Carts and
Carriers



ToteMaster™ Open Top

- > Holds up to 33 volleyballs, nets, pads and other equipment
- > 2 full-size open top storage baskets with 4" x 3" wire mesh
- > Upper basket deeper than lower basket and ideal for larger items
- > 4 swivel wheels
- > Dimensions: 26"W x 48"L x 54"H

TE-PE01 48 lbs \$249 each **3Y**

TOTEMASTER™



Deluxe 15 Ball Carrier

- > Highly durable
- > All welded 1" OD steel frame and crossbars
- > Holds up to 15 volleyballs
- > 4 heavy-duty swivel wheels
- > Dimensions: 36"H x 22"W x 39"L

BBC-12RB 27 lbs **ROYAL BLUE** \$149 each **3Y**
BBC-12BK 27 lbs **BLACK** \$149 each **3Y**
BBC-12RD 27 lbs **RED** \$149 each **3Y**

Deluxe 21 Ball Carrier

- > Highly durable
- > All welded 1" OD steel frame and crossbars
- > Holds up to 21 volleyballs
- > 4 heavy-duty swivel wheels
- > Dimensions: 36"H x 22"W x 60"L

BBC-18RB 41 lbs **ROYAL BLUE** \$172 each **3Y**
BBC-18BK 41 lbs **BLACK** \$172 each **3Y**
BBC-18RD 41 lbs **RED** \$172 each **3Y**

System Replacement Parts

Worm Drive Winch

- > Leader strap & handle included

PVBWINCH 6 lbs \$375 each **3Y**

Cargo Buckle Winch

HM5044 3 lbs \$79 each **3Y**

Leader Strap (for HM5044)

PVB101A 2 lbs \$55 each **3Y**

Leader Strap (for PVBWINCH)

PVB603 1½" wide 1 lb \$65 each **3Y**

Winch Handle (for PVBWINCH)

VBW-HANDLE-08 (for winches purchased after 2008)
1 lb \$65 each **3Y**

Handle

> For telescoping height adjustment and old blue style winch
PVB607I (requires 3/8" allen wrench)
1 lb \$34 each **3Y**

Pin Chain Assembly

PVB512 (1500/5000/4500)
2 lbs \$12 each **3Y**

Ceiling Suspended Volleyball System



Save on external storage and set-up time with a Ceiling Suspended Volleyball System by Jaypro Sports. This system stores fully assembled and close to the ceiling, raised and lowered using a 1 HP winch, and is offered with or without an attached referee stand. Additionally, the net height is infinitely adjustable to meet both men's and women's regulation heights.

Ceiling Suspended Volleyball System

Conveniently raises and lowers volleyball system with a turn-key solution for quick set-up in minutes.

- > Meets NCAA and NFHS regulations
- > System raises to fold in either direction (specify fold direction when ordering)
- > Available with or without a 24" x 36" all-welded and attached referee stand with anti-skid diamond plate platform (250 lb capacity)
- > Dual Posilok™ safety straps automatically lock system in position should a malfunction occur during raising or lowering of unit
- > Engraved height markers for quick set-up (0-20" range)
- > Retractable foot system for maximum stability during playing conditions
- > Net height adjustment handles on both uprights
- > Exposed posts and frames fully padded for player safety
- > Competition high school volleyball net included
- > 1 pair of universal net antennae included

PVBOH-880R System with Referee Stand
Call for Pricing

PVBOH-800 System without Referee Stand
Call for Pricing



Training Equipment



The Spiker

best seller



- > Develop spiking/serving skills
- > 6'-12' aluminum telescoping pole with foam ball holder
- > Polyethylene base included

TS612 11 lbs \$239 each
  



The Jumper

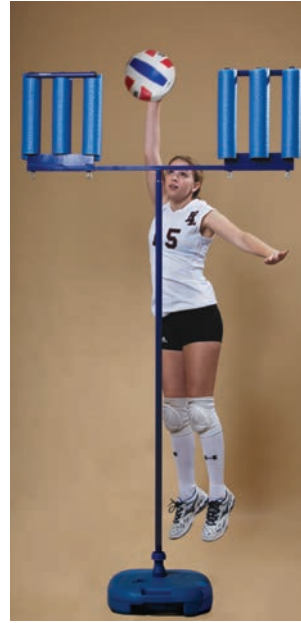

- > Measure jump reach
- > Color coded spring pegs in 1" increments
- > 6'-12' aluminum telescoping pole
- > Polyethylene base included

TJ612 10 lbs \$199 each
  



The Attacker



- > Practice game-like blocking situations
- > 2 adjustable 1' x 1½' foam blocking surfaces
- > Four knobs for easy adjustment
- > Polyethylene base included

TA115 15 lbs \$299 each
  



The Blocker

- > Practice defending blocked spikes
- > Aluminum pole adjusts up to 11'
- > 2' x 3' foam blocking surface
- > Polyethylene base included

TB11 13 lbs \$289 each
  



www.jaypro.com
 T: 800-243-0533 F: 800-988-3363

T: 800-243-0533

Volleyball Training Package

- > The Spiker (TS612)
- > The Jumper (TJ612)
- > The Attacker (TA115)
- > The Blocker (TB11)

VTAPACK

49 lbs
 \$729 package



Attack II Volleyball Machine



Maximize daily practice drills with accurate and repeatable reps. **See page 81 for details about this product.**

VBSA-2 200 lbs
 \$3,149 each 

Polyethylene Base



- > For use with The Spiker, The Jumper, The Attacker and The Blocker
- > Filling base with sand is recommended

FPB1 13 lbs \$40 each
 



Coastal Competition Volleyball System

- > Designed to withstand coastal winds and weather
- > 4" square extruded heavy-walled aluminum uprights with additional lateral support inside
- > Adjustable winches for play at any height
- > Ground sleeves, installation tool, 2 winches and weather resistant net included

Inside lateral support



OCC-500	System	178 lbs	\$1,395 system	FR	3Y
OCC-500N	Replacement Net	8 lbs	\$179 each		1Y

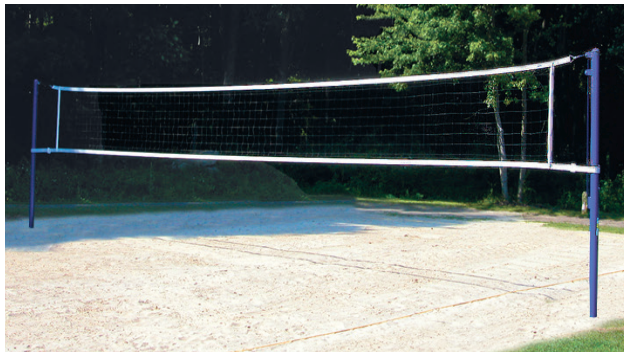

Outdoor Competition Volleyball System

- > 3½" OD heavy-walled galvanized steel uprights are powder coated
- > Fixed net heights for men's and women's play
- > 36" aluminum ground sleeves with cover caps
- > Rust-resistant ratchet included
- > Snap buckles for quick net attachment
- > Net (PVBN-3 or PVBN-6J) sold separately

OCV-900	System	170 lbs	\$997 system		
OCV-900C	Center Package	90 lbs	\$589 each	FR	3Y



Recreational Outdoor Volleyball System

Ideal for accommodating volleyball, badminton or tennis.

- > 2¾" OD galvanized steel uprights
- > PVC ground sleeves with top caps
- > Rust-resistant ratchet included
- > Net (VBN-32, VBD-6 or VBD-3) sold separately

Ground sleeves are designed to be set even with playing surface. Contact Jaypro Sports for special installation requirements.

OS-350	80 lbs	\$599 system	FR	3Y
---------------	--------	--------------	----	----



Adjustable Volleyball Court Line

- > 2" wide black webbed volleyball boundary line
- > Adjusts from 30' x 60' to FIVB regulation (8m x 16m)
- > 8" corner stakes with bungee cord to ensure adjustment to court boundary
- > Plastic reel for easy assembly and storage included

AVCL-2	2 lbs	\$59 each	3Y
---------------	-------	-----------	----



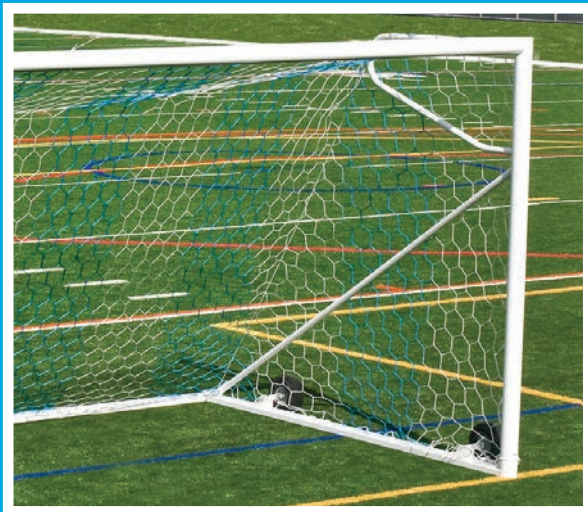

NOVA™ Premiere Goal Package (Black/White)

- > 2 NOVA™ Premiere Goals (SGP-600)
- > (2) 5mm, 5½” hex mesh two-tone black/white nets (SN-2BLKW)
- > 8 World Cup Anchors - 2 Sets (SGA-50)
- > 1 NOVA™ Goal Wheel Kit (NSGWK)

SGP-600PKGBLK

531 lbs

\$5,209 package



NOVA™ Premiere Goal Package (Blue/White)

- > 2 NOVA™ Premiere Goals (SGP-600)
- > (2) 5mm, 5½” hex mesh two-tone blue/white nets (SN-2BLUW)
- > 8 World Cup Anchors - 2 Sets (SGA-50)
- > 1 NOVA™ Goal Wheel Kit (NSGWK)

SGP-600PKGBLU

531 lbs

\$5,209 package



Classic Official Round Goal Package



- > 2 Classic Round Official Goals (SGP-400)
- > (2) 4mm, 5½” sq mesh white nets (SND-8)
- > 8 Sandbag Anchors - 2 Sets (SWB-454W)
- > 1 Classic Wheel Kit (CSGWK)

SGP-400PKG

496 lbs

\$3,297 package





Classic Official Square Goal Package



- > 2 Classic Square Official Goals (SGP-760)
- > (2) 4mm, 5½” sq mesh white nets (SND-8)
- > 8 Sandbag Anchors - 2 Sets (SWB-454W)
- > 1 Classic Wheel Kit (CSGWK)

SGP-760PKG

500 lbs

\$3,297 package

FR 12Y 3Y 1Y ★



Deluxe Classic Official Round Goal Package



- > 2 Classic Round Official Goals (SGP-400)
- > (2) 4mm, 5½” sq mesh white nets (SND-8)
- > 8 World Cup Anchors - 2 Sets (SGA-50)
- > 1 Classic Wheel Kit (CSGWK)

SGP-400PKGDX

496 lbs

\$3,699 package

FR 12Y 3Y 1Y ★



Deluxe Classic Official Square Goal Package



- > 2 Classic Square Official Goals (SGP-760)
- > (2) 4mm, 5½” sq mesh white nets (SND-8)
- > 8 World Cup Anchors - 2 Sets (SGA-50)
- > 1 Classic Wheel Kit (CSGWK)

SGP-760PKGDX

500 lbs

\$3,699 package

FR 12Y 3Y 1Y ★



www.jaypro.com
T: 800-243-0533

F: 800-988-3363

NOVA™ a **jaypro sports™** product



Easy Track™ Net Attachment System



Wheel Kit Included



Optional Premium Counterweights



NOVA™ Ultimate Folding Goal

Features Jaypro Sports flush mount Easy Track™ net attachment system with clips.

- > NCAA, FIFA and NFHS compliant
- > Official size and powder coated
- > Locks in folded position for storage and safety (lock not included)
- > Spring assist design ensures goal opens and folds safely
- > 4" OD extruded aluminum with a 2" x 4" base frame
- > 1.7" OD aluminum European backstays
- > 4mm white official net
- > 10" no-flat wheels
- > Stainless steel hardware included
- > Ground anchors and counterweights sold separately
- > Dimensions: 24'W x 8'H x 4'B x 10'D

In-ground anchors or appropriate amount of counterweight required per goal. See chart on page 28 for ASTM counterweight requirements for your specific goal.

SGP-600FS

475 lbs

\$5,795 pair



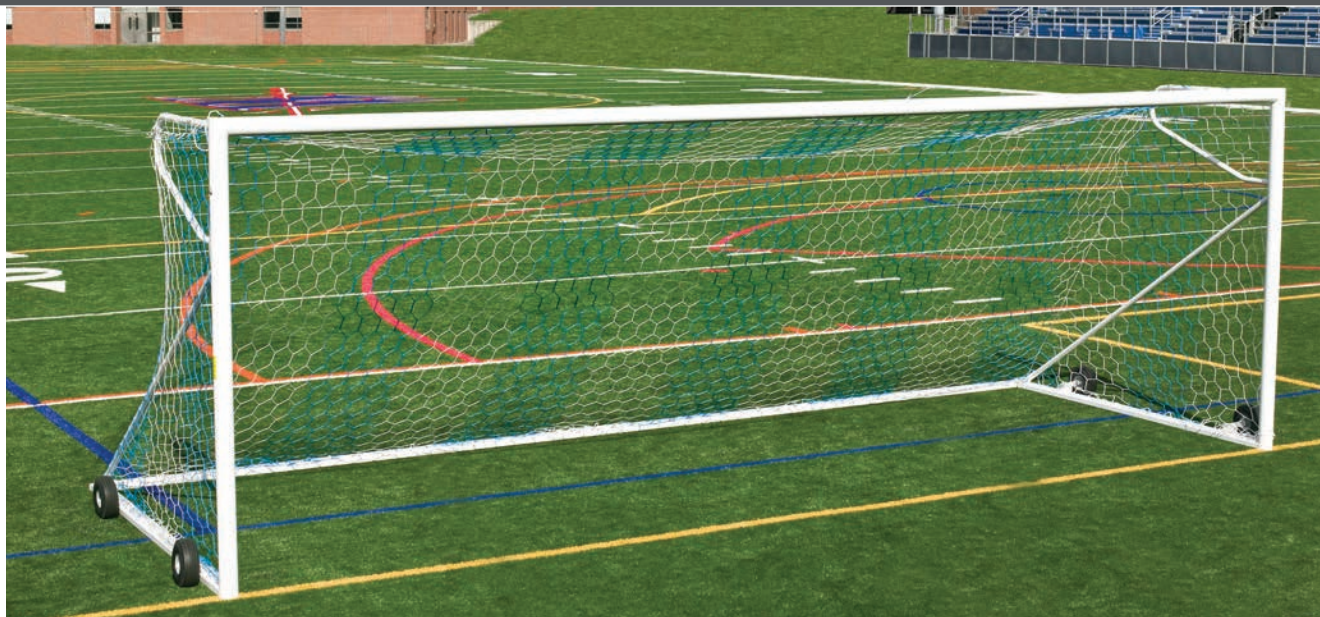

Easy Track™ Net Attachment System



Optional Wheel Kit



Optional Premium Counterweights



NOVA™ Premiere Goal

Features Jaypro Sports flush mount Easy Track™ net attachment system with clips.

- > NCAA, FIFA and NFHS compliant
- > Official size and powder coated
- > International style all aluminum goal
- > 4" OD extruded aluminum with a 2" x 4" base frame
- > 1.7" OD aluminum European and auxiliary backstays
- > Optional Wheel Kit (NSGWK) sold separately
- > Stainless steel hardware included
- > Nets sold separately
- > Ground anchors and counterweights sold separately
- > Dimensions: 24'W x 8'H x 4'B x 10'D

In-ground anchors or appropriate amount of counterweight required per goal. See chart on page 28 for ASTM counterweight requirements for your specific goal.

SGP-600

446 lbs

\$4,795 pair



NOVA™ Premiere Adjustable Goal

Same as NOVA™ Premiere Goal (SGP-600) except with:

- > Infinitely adjustable rear crossbar allows goal to fit under any football goal post
- > No fixed settings and no fixed depth on crossbar (move a yard, a foot or inch)
- > Dimensions: 24'W x 8'H x 4'B x 10'D

In-ground anchors or appropriate amount of counterweight required per goal. See chart on page 28 for ASTM counterweight requirements for your specific goal.

SGP-600AX 364 lbs \$4,989 pair



NOVA™ Wheel Kit

Attaches to any NOVA™ goal base (SGP-600 and NOVA™ club round and square)

- > (4) 10" no-flat wheels
- > Quick and easy wheel engagement
- > Kit equips 2 goals

NSGWK 33 lbs \$485 kit **3Y**



www.jaypro.com
T: 800-243-0533

F: 800-988-3363



NOVA™ World Fold-Up Goal

Features Jaypro Sports flush mount Easy Track™ net attachment system with clips.

- > NCAA, FIFA and NFHS compliant
- > Official size International style aluminum goal is powder coated
- > Field maintenance friendly with fold-up rear frame can be temporarily pinned or permanently locked in raised position
- > 4" OD extruded aluminum with a 2" x 4" base frame
- > 2 3/8" galvanized steel back posts
- > Ground sleeves for semi-permanent installation included
- > World competition hex net and stainless steel hardware included
- > Ground anchors and counterweights sold separately
- > Dimensions: 24'W x 8'H x 6'B x 6'D

SGP-660 534 lbs \$4,895 pair



NOVA™ World Classic Goal

Same as NOVA™ World Fold-Up Goal (SGP-660) except without fold-up rear frame.

- > Dimensions: 24'W x 8'H x 6'B x 6'D

SGP-550 432 lbs \$3,495 pair



Easy Track™ Net Attachment System

Soccer Field Netting

FieldPro™ Soccer Ball Stop System

Stop wasting time chasing missed shots or errant passes during practice and games. Ensure the safety of athletes, coaches and spectators.

- > Designed to fit behind soccer goals
- > (4) 4" OD heavy-walled aluminum uprights with ground sleeves and covers
- > #36 knotted black nylon net with 1 3/4" sq mesh and 1/4" rope border
- > Pulley system to raise/lower net included
- > Corrosion resistant hardware included
- > Dimensions: 20'H x 65'L (custom sizes available)

See page 111-113 for more FieldPro™ Net System options.

FNSB-65 250 lbs \$2,250 each

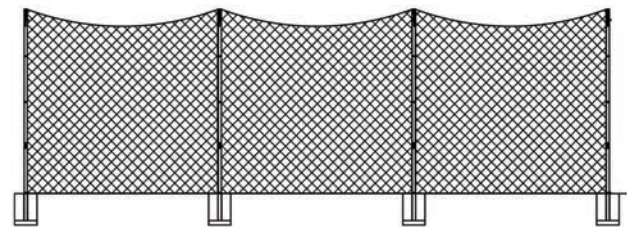



Classic Official Round Goal



Features Jaypro Sports flush mount Easy Track™ net attachment system with clips.

- > NCAA, FIFA and NFHS compliant
- > Official size and powder coated
- > 4" OD extruded aluminum
- > 1.9" OD galvanized steel backstays and rear crossbar
- > Optional Classic Wheel Kit (CSGWK) sold separately
- > Net sold separately
- > Ground anchors and counterweights sold separately
- > Dimensions: 24'W x 8'H x 4'B x 10'D

In-ground anchors or appropriate amount of counterweight required per goal. See chart on page 28 for ASTM counterweight requirements for your specific goal.

SGP-400 420 lbs \$2,849 pair
 FR ● 12Y ★ X

Classic Official Round Goal (Semi-Permanent)

Same as Classic Official Round Goal (SGP-400) except with 10' uprights for insertion into ground.

- > Dimensions: 24'W x 8'H x 4'B x 10'D

SGP-440 Galvanized Steel Backstays
 306 lbs \$2,549 pair FR ● 12Y ★ X

SGP-440EB European Backstays
 306 lbs \$2,649 pair FR ● 12Y ★ X

SGP-445G Ground Sleeves (Set of 4)
 28 lbs \$499 set 3Y

Steel Backstays



European Backstays



Classic Official Square Goal



Features Jaypro Sports flush mount Easy Track™ net attachment system with clips.

- > NCAA, FIFA and NFHS compliant
- > Official size and powder coated
- > 4" square extruded aluminum
- > 1.9" OD galvanized steel backstays and rear crossbar
- > Optional Classic Wheel Kit (CSGWK) sold separately
- > Net sold separately
- > Ground anchors and counterweights sold separately
- > Dimensions: 24'W x 8'H x 4'B x 10'D

In-ground anchors or appropriate amount of counterweight required per goal. See chart on page 28 for ASTM counterweight requirements for your specific goal.

SGP-760 416 lbs \$2,849 pair
 FR ● 12Y ★ X

Classic Official Square Goal (Semi-Permanent)

Same as Classic Official Square Goal (SGP-760) except with 10' uprights for insertion into ground.

- > Dimensions: 24'W x 8'H x 4'B x 10'D

SGP-730 Galvanized Steel Backstays
 241 lbs \$2,549 pair FR ● 12Y ★ X

SGP-730EB European Backstays
 241 lbs \$2,649 pair FR ● 12Y ★ X

SGP-735G Ground Sleeves (Set of 4)
 28 lbs \$499 set 3Y

Classic Wheel Kit



Attaches to any goal base (SGP-760, SGP-400 and SGP-100). Can be used with Classic Club Goal fitted with optional rear ground crossbar.

- > (4) 10" no-flat wheels
- > Quick and easy wheel engagement
- > Kit equips 2 goals

CSGWK 33 lbs \$485 kit 3Y



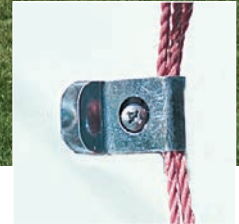

"Money Clip" style net attachment

Team Official Square Goal

- > NCAA and NFHS compliant
- > Official size and powder coated
- > 4" x 2" steel with 1.9" OD galvanized steel backstays and rear crossbar
- > Rear crossbar and backstays improve stability and safety
- > Backstays run back 10' for a more stable base as opposed to 8' and 9' like most goals
- > Economical soccer goal
- > "Money-Clip" style net attachment system
- > Optional Classic Wheel Kit (CSGWK) sold separately
- > Net sold separately
- > Ground anchors and counterweights sold separately
- > Dimensions: 24'W x 8'H x 4'B x 10'D

In-ground anchors or appropriate amount of counterweight required per goal. See chart on page 28 for ASTM counterweight requirements for your specific goal.

SGP-100

571 lbs

\$2,495 pair



Team Official Round Goal (Semi-Permanent)

- > Designed without backstays for permanent/semi-permanent installation
- > Official size and powder coated
- > 4" OD 14 Gauge steel uprights and crossbar
- > Nets, net clips and net pegs included
- > Aluminum ground sleeves with locking caps for semi-permanent installation available
- > Ground anchors and counterweights sold separately
- > Dimensions: 24'W x 8'H

SGP-200

280 lbs

\$2,100 pair



SGP-200G

Ground sleeves (Set of 4)

28 lbs

\$515 set



www.jaypro.com
F: 800-988-3363

T: 800-243-0533



Stable Anchored Base

The powder coated white ground base assembly lies flat on the ground. The ground stake is inserted through the middle of the base to anchor it to the ground. The upright is placed over a sleeve on the base assembly, resulting in a stable goal with no visible anchor to cause a tripping hazard.

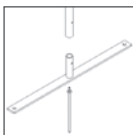

Portable Training Goal

Ideal for European style training.

- > Lightweight and stable
- > 2" OD heavy-walled aluminum frame with stabilizing ground base plates
- > 4" sq mesh nylon net and carry bag included
- > Available in two sizes
- > Powder coated white

STG-718	Medium Goal - 18W' x 7½'H	44 lbs	\$605 each		
STG-718N	Medium Replacement Net	4 lbs	\$69 each		
STG-824	Large Goal - 24W' x 8'H	62 lbs	\$675 each		
STG-824N	Large Replacement Net	5 lbs	\$99 each		



Stable Anchored Base

The powder coated white ground base assembly lies flat on the ground. The ground stake is inserted through the middle of the base to anchor it to the ground. The upright is placed over a sleeve on the base assembly, resulting in a stable goal with no visible anchor to cause a tripping hazard.

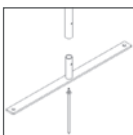

Soccer Rebounder

- > Lightweight and stable
- > 2" OD heavy-walled aluminum frame with stabilizing ground base plates
- > Crossbar along bottom with additional ground base plate
- > 1½" sq mesh net with 1/8" cord and bungee net attachments
- > Carry bag included
- > Available in two sizes
- > Powder coated white

STGRB718	Medium Rebounder	48 lbs	\$715 each		
RB718N	Medium Rebound Net	5 lbs	\$89 each		
STGRB824	Large Rebounder	67 lbs	\$845 each		
RB824N	Large Rebound Net	6 lbs	\$109 each		



Equipment Carry Bag

Ideal for transporting and storing goals or rebounders.

- > Heavy-duty black Cordura bag with reinforced zipper
- > Includes carry straps and handles on each end
- > Large bag holds the Quick Set-up Goal (SEYL-824)
- > Medium bag holds Portable Training Goal and Soccer Rebounder
- > Small bag holds Two-For-Youth Goal (MPG-46) and miscellaneous items

ECB-LG	Large Bag	6 lbs	\$79 each	
ECB-MD	Medium Bag	5 lbs	\$69 each	
ECB-SM	Small Bag	4 lbs	\$59 each	



Bungees

Replace old and worn bungees.

- > (30) 6" long bungees
- > Two bags required for Medium Soccer Rebounder (STGRB718)
- > Three bags required for the Large Soccer Rebounder (STGRB824)

STGRB718B	2 lbs	\$29 bag	
------------------	-------	----------	--



NOVA™ Club Goal



NOVA™ Club Round Goal

Features Jaypro Sports flush mount Easy Track™ net attachment system with clips.

- > 2 white powdered coated all aluminum portable goals
- > 3" OD extruded front frame
- > 1⁵/₁₆" European and auxiliary backstays
- > 3" extruded aluminum full ground base frame
- > (2) 4" sq mesh white nets
- > Optional NOVA™ Wheel Kit (NSGWK) sold separately
- > Easy Track™ net clips and sandbags included
- > Stainless steel hardware included

In-ground anchors or appropriate amount of counterweight required per goal. See chart below for ASTM counterweight requirements for your specific goal.



Easy Track™ Net Attachment System



Optional Wheel Kit



Optional Premium Counterweights



NOVA Club Round

Item	Weight	Counter Weight	Size	Price
RCG-24S	402 lbs	150 lbs	8'H x 24'W x 4'B x 9'D	\$3,799 set
RCG-21S	358 lbs	170 lbs	7'H x 21'W x 3'B x 8'D	\$3,499 set
RCG-18S	310 lbs	240 lbs	6½'H x 18½'W x 2'B x 6'D	\$3,399 set
RCG-12S	264 lbs	240 lbs	6½'H x 12'W x 2'B x 6'D	\$2,999 set
RCG-9S	218 lbs	*	4½'H x 9'W x 2'B x 5'D	\$2,599 set
RCG-6S	198 lbs	*	4'H x 6'W x 2'B x 5'D	\$2,299 set

Soccer Goal Counterweight Chart

Item #	Counterweight required per goal	NOVA World Cup Anchors or Sand Bags required per goal
SGP-600FS	140 lbs	3 per goal
SGP-600	140 lbs	3 per goal
SGP-400	160 lbs	4 per goal
SGP-760	140 lbs	3 per goal
SGP-100	170 lbs	4 per goal
RCG-24S	150 lbs	3 per goal
CC24S	140 lbs	3 per goal
RCG-21S	170 lbs	4 per goal
CC21S	160 lbs	4 per goal
RCG-18S	240 lbs	5 per goal
CC18S	240 lbs	5 per goal
RCG-12S	240 lbs	5 per goal
CC12S	240 lbs	5 per goal



NOVA™ Wheel Kit

Attaches to any NOVA™ goal base (SGP-600 and NOVA™ club round and square)

- > (4) 10" no-flat wheels
- > Quick and easy wheel engagement
- > Kit equips 2 goals

NSGWK 33 lbs \$485 kit **3Y**



Classic Club Goal



Classic Club Goal

Features Jaypro Sports flush mount Easy Track™ net attachment system with clips.

- > 2 powder coated and natural finish portable goals
- > 2" OD galvanized steel rear ground crossbar included on the three largest sizes offered
- > 3" OD extruded aluminum front frame with 2" OD galvanized steel backstays
- > (2) 4" sq mesh white nets
- > Optional NOVA™ Wheel Kit (CSGWK) sold separately
- > Easy Track™ net clips and sandbags included

In-ground anchors or appropriate amount of counterweight required per goal. See chart on page 28 for ASTM counterweight requirements for your specific goal.



Easy Track™ Net Attachment System



Optional Wheel Kit



Optional Premium Counterweights



Classic Club Round

Item	Weight	Counter Weight	Size	Price
CC24S	395 lbs	140 lbs	8'H x 24'W x 4'B x 9'D	\$2,398 set
CC21S	345 lbs	160 lbs	7'H x 21'W x 3'B x 8'D	\$2,198 set
CC18S	299 lbs	240 lbs	6½'H x 18½'W x 2'B x 6'D	\$1,998 set
CC12S	188 lbs	240 lbs	6½'H x 12'W x 2'B x 6'D	\$1,698 set
CC9S	157 lbs	*	4½'H x 9'W x 2'B x 5'D	\$1,498 set
CC6S	145 lbs	*	4'H x 6'W x 2'B x 5'D	\$1,398 set

Which size goal does your program need?

Age Group	Recommended Goal Size	Maximum Ball Size	Minimum Players/Team
U-13	8' x 24'	5	11 vs 11
U-12	Up to 6½' x 18½'	4	9 vs 9
U-11	Up to 6½' x 18½'	4	9 vs 9
U-10	Up to 6½' x 18½'	4	7 vs 7
U-9	Up to 6½' x 18½'	4	7 vs 7
U-8	Up to 4' x 6'	3	4 vs 4
U-6/U-7	Up to 4' x 6'	3	4 vs 4



Classic Wheel Kit

Attaches to any goal base (SGP-760, SGP-400 and SGP-100). Can be used with Classic Club Goal fitted with optional rear ground crossbar.

- > (4) 10" no-flat wheels
- > Quick and easy wheel engagement
- > Kit equips 2 goals

CSGWK

33 lbs

\$485 kit

3Y



www.jaypro.com
T: 800-243-0533

F: 800-988-3363

Futsal Goals

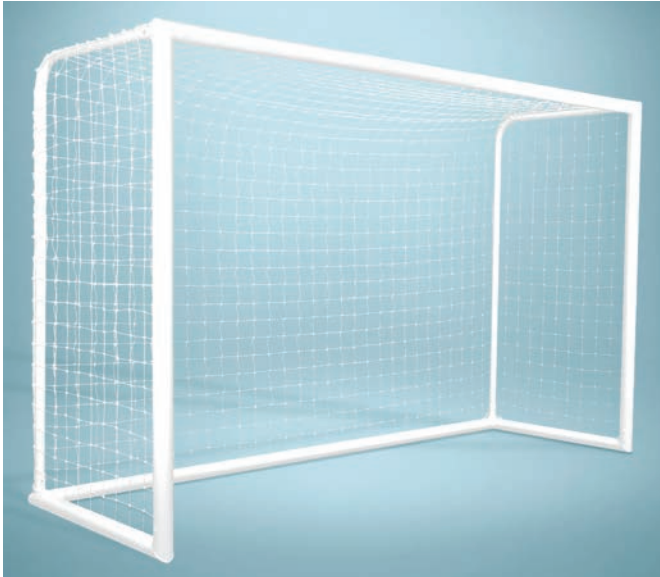

Deluxe Official Futsal Goal



Features Jaypro Sports flush mount Easy Track™ net attachment system with clips.

- > Official size and powder coated white
- > 3" OD round aluminum goal face and base with extruded channel
- > 1¼" round heavy-walled aluminum backstays
- > Polyethylene white net with 4" sq mesh
- > Stainless steel hardware included
- > Optional NOVA™ Wheel Kit (NSGWK) sold separately
- > Dimensions: 9'10"W x 6'7"H x 3'3"D

FSG-1 \$1,499 each **FR** **3Y** **1Y** **AS**



Official Futsal Goal

Features Jaypro Sports flush mount Easy Track™ net attachment system.

- > 1 white powdered coated portable goal
- > Extruded aluminum frame
- > Official size 9'10"W (3m) x 6'7"H (2m) meets specifications
- > (1) 4' sq mesh nets
- > Easy Track™ net clips and non-marring floor protectors included

FSG-2 Goal **FR** **3Y** **AS**
120 lbs \$1,249 each

FSG67910NHP Replacement Net 4 lbs \$85 each **1Y**

FSGWK Wheel Kit 20 lbs \$244 set **3Y**



Practice Futsal Goal



- > Official size and powder coated white
- > Folds for portability and storage
- > 1.90" OD heavy-duty steel galvanized pipe goal face
- > 1½/16" OD steel galvanized pipe backstays
- > 4" sq mesh net held in place with Velcro straps
- > Non-marring floor protectors
- > Dimensions: 9'10"W x 6'7"H x 3'3"D

FPG-23 \$749 each **FR** **3Y** **1Y** **AS**



Quick Set-Up Goal

Ideal for any league or backyard use.

- > Sets up in minutes with quick release push pins
- > 2" OD aluminum frame
- > Goal width adjusts to 8', 16' or 24' x 8'H
- > Net, 6 net pegs, indoor floor pads and carry bag included



SEYL-824

52 lbs

Goal
\$809 each

3Y AS

SEYL-24NHP

7 lbs

Replacement Net
\$120 each

1Y



Rugged Play Goal

Ideal for precision shooting drills or short-sided games.

- > Outdoor/indoor use
- > Quick release push-pins make break down easy
- > 2" OD galvanized steel frame powder coated silver
- > 2.5mm orange polyethylene net with 4" sq mesh
- > Includes rubber feet to protect gymnasium floor
- > Dimensions: 8'W x 4'H x 4'D

SMG-8HP

45 lbs

Goal
\$235 each

3Y AS

SMG-8NHP

5 lb

Replacement Net
\$39 each

1Y



Two-For-Youth Goal

- > Two sizes in one (4'x6' or flip to 3'x6')
- > Easy quick release push pin assembly
- > 1½" OD aluminum frame powder coated white
- > 1¾" sq black mesh net
- > Hook-and-loop attachment

MPG-46

23 lbs

Goal
\$249 each

3Y

MPG-46N

2 lbs

Replacement Net
\$40 each

1Y



Practice/Youth Goals

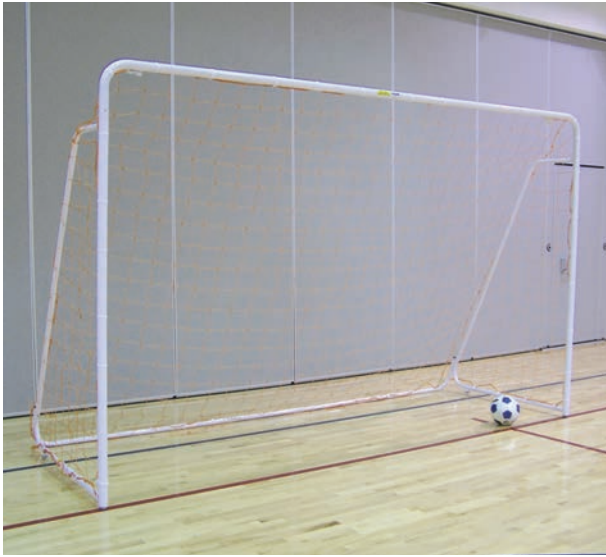

Indoor/Outdoor Folding Goal



Ideal for competitive indoor play and as an outdoor training/youth goal.

- > Indoor/outdoor use
- > Versatile and durable
- > 2" OD zinc undercoated steel frame powder coated white
- > 1 5/16" OD backstays fold without removing net
- > 4" sq mesh nets
- > Hook-and-loop net straps eliminate lacing
- > Non-marring floor protectors included
- > Dimensions: 12'W x 7'H x 4'D

See page 35 for ground anchors for outdoor use.

SFG-14HP

Goal 81 lbs
\$399 each **FR** **3Y** **AS**

SFG-14NHP

Replacement Net 3 lbs
\$75 each **1Y**

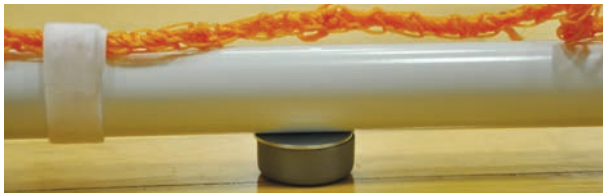

Floor Protector Kit

Ideal for using Portable Short-Sided Soccer Goals indoors.

- > Help protect gymnasium floor from being scratched or damaged
- > Kit includes self-threading screws with 4 rubber feet

PSS-4FT 2 lbs \$30 kit **3Y**



Portable Short-Sided Soccer Goals

Ideal for 4 vs 4 play or 3 vs 3 play.

- > 1 5/16" OD galvanized steel frame powder coated white
- > All-welded side frames and rear ground crossbars for increased strength and durability
- > Snap pins lock frame in place for added safety
- > Folds for easy transport and storage
- > 2.5mm twisted net with 4" sq mesh
- > Ground anchors and net ties included
- > Optional Floor Protection Kit (PSS-4FT) sold separately to use indoors

For 4 vs 4 Play:

PSS-612 12'W x 6'H x 31"D Goal 63 lbs \$290 each **3Y** **AS**

PSS-612N Replacement Net 3 lbs \$47 each **1Y**

PSS-608 8'W x 6'H x 31"D Goal 60 lbs \$270 each **3Y** **AS**

PSS-608N Replacement Net 2 lbs \$45 each **1Y**

PSS-510 10'W x 5'H x 34"D Goal 57 lbs \$250 each **3Y** **AS**

PSS-510N Replacement Net 2 lbs \$43 each **1Y**

For 3 vs 3 Play:

PSS-406 6'W x 4'H x 24"D Goal 40 lbs \$230 each **3Y** **AS**

PSS-406N Replacement Net 2 lbs \$39 each **1Y**





Soccer Pop-Up Trainers

Ideal for 3 vs 3 play in the backyard or at the beach and park.

- > Durable and safe lightweight pop-up goals
- > Fiberglass rod frame with steel spring corners and heavy-duty net
- > Equipped with anchoring pegs to ensure stability
- > Folds down to 1" flat oval
- > Available in 2 sizes
- > Zipper nylon bag with handles included

SGPU4830R Small Goal - 4'W x 2½'H x 2½'D (Red)
4 lbs \$79 pair **1Y**

SGPU7240B Large Goal - 6'W x 3'4"H x 3'4"D (Blue)
6 lbs \$99 pair **1Y**



Roll-A-Goal

Ideal for short-sided games and developing shooting skills.

- > Indoor/outdoor use
- > 1½" OD steel frame folds flat for compact storage
- > Non-marking front wheels for easy transport
- > Durable knotless nylon net with vinyl sleeves
- > Hook-and-loop closures (no lacing required)
- > Available in 3 sizes

STG-23 Small Goal - 3'W x 2'H
25 lbs \$109 each **3Y AS**

STG-23N Replacement Net
3 lbs \$55 each **1Y**

STG-34 Medium Goal - 4'W x 3'H
25 lbs \$159 each **3Y AS**

STG-34N Replacement Net
4 lbs \$65 each **1Y**

STG-46 Large Goal - 6'W x 4'H
39 lbs \$195 each **3Y AS**

STG-46N Replacement Net
3 lbs \$85 each **1Y**



Adjustable Soccer Rebounder

Ideal training for developing players and especially goalies.

- > 3 adjustable playback angles
- > 1¼" OD heavy-duty steel frame and support base
- > White mesh net with 1/8" cord
- > Powder coated black
- > Folds flat for easy transport and storage
- > Rebound Surface: 40"W x 40"H

ASR33BK 27 lbs \$229 each **3Y AS**



WORLD CUP™ ANCHOR

a **jaypro sports** product



World Cup Anchor™

Ideal where in-ground anchoring devices are not appropriate.

- > Tank style anchor has 4¾"W x 3¼"H opening designed to fit over any round or flat rear crossbar
- > Hard plastic shell will not crack when filled in the field with 50 lbs concrete, 30 lbs sand or 24 lbs water
- > Built-in carry handle and stackable design for convenient storage
- > Bright yellow color for visibility and safety
- > Dimensions: 12"W x 8½"H

See chart on page 28 for ASTM counterweight requirements for your specific goal.

SGA-50

Set of 4 12 lbs \$289 set **3Y** ★ ✕ AS

SGA-51

Single 3 lbs \$79 each **3Y** ★ ✕ AS



Multi-Use Soccer Cart

Ideal for transporting awkward and heavy soccer field equipment like goal anchors, corner flags and balls.

- > Heavy-duty utility cart
- > Pull by hand or tow by ATV/Utility Tractor
- > Fold-down sides for easy loading
- > (4) 13" x 5" wide pneumatic turn wheels rated to hold up to 350 lbs
- > Holds up to 16 World Cup Anchors™ (SGA-50)
- > Dimensions: 26"W x 51"L

SGA-CART \$649 each **3Y**



Roller Assembly Kit



Soccer goal counterweights and wheels for mobility combined into one unit.

- > Exceeds all ASTM F2950 tip over standards
- > Helps eliminate risk of accidental tip overs
- > Replaces ineffective J-hooks, tent stakes, augers and loose sand bags
- > Attaches securely to any rear ground bar
- > Durable polyethylene rollers are immune to weather conditions and roll easily on any surface
- > Fill in the field with sand (customer supplied)
- > Provides permanent ballast system

SSG-R2 \$740 pair **3Y** ★





Sandbag Anchor

Ideal where in-ground anchoring devices are not appropriate.

SWB-451	Bag w/ Steel Handle 3 lbs	\$59 each	3Y ★ AS
SWB-454	Bag w/ Steel Handle - Set of 4 12 lbs	\$215 set	3Y ★ AS
SWB-451PK	Bag w/ Steel Handle (Pink) 3 lbs	\$63 each	3Y ★ AS
SWB-454PK	Bag w/ Steel Handle (Pink) - Set of 4 12 lbs	\$225 set	3Y ★ AS

- > Fill sandbag in the field with 50 lbs of dry sand
- > Choose from steel carry handle or nylon strap design
- > May come in different colors - available in Team Pink

SWB-451W	Bag w/ Nylon Handle 2 lbs	\$43 each	3Y ★ AS
SWB-454W	Bag w/ Nylon Handle - Set of 4 8 lbs	\$150 set	3Y ★ AS
SWB-451WPK	Bag w/ Nylon Handle (Pink) 2 lbs	\$48 each	3Y ★ AS
SWB-454WPK	Bag w/ Nylon Handle (Pink) - Set of 4 8 lbs	\$160 set	3Y ★ AS

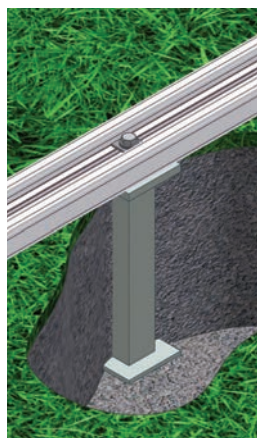

In-Ground Anchor

Provides the surest means of anchoring soccer goals.

- > Securely anchors any portable NOVA™ goal or existing goal with minor modification
- > Will not pull out or slide off the base frame
- > Set includes 2 anchors for one goal

SGA-60 Set of 2 13 lbs
\$205 set **3Y**

Counterweight Requirements

See chart on page 28 for ASTM counterweight requirements for your specific goal.



Auger Anchor

Ideal for use in loose and sandy soil.

- > 18" steel auger with steel wire lanyard

SAS-95 Set of 4 5 lbs
\$70 set **3Y**



J-Hook Stake

Ideal for use in firm and compressed soil.

- > 18" durable "J" style steel stake with steel wire lanyard

SGA-91 Set of 4 16 lbs
\$99 set **3Y**



Spike Anchor

Ideal for use in firm and tightly compacted soil.

- > 18" long 3/4" galvanized steel spike with steel wire lanyard

SS-18 Set of 4 12 lbs
\$109 set **3Y**



Youth Goal Anchor

- > 3/8" dia and 15 1/2" long
- > Not appropriate for official goals

217RP Set of 4 2 lbs
\$50 set **3Y**



Soccer Nets



2 Tone Hexagon

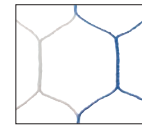

Economical Twist



Durable Braid



	Item #	Size	Mesh	Twine	Color	Weight	Price
OFFICIAL	SND-8*	8' x 24' x 4' x 10'	5½" sq	4mm Braid	WHITE	25 lbs	\$249 pair
	SND-7*	8' x 24' x 4' x 10'	5½" sq	4mm Braid	ORANGE	25 lbs	\$249 pair
	SN-40B*	8' x 24' x 4' x 10'	5½" sq	4mm Braid	BLUE	25 lbs	\$306 pair
	SN-40R*	8' x 24' x 4' x 10'	5½" sq	4mm Braid	RED	25 lbs	\$306 pair
	SN-40Y*	8' x 24' x 4' x 10'	5½" sq	4mm Braid	YELLOW	25 lbs	\$306 pair
	SN-HTTP-W*	8' x 24' x 4' x 10'	5½" hex	5mm Braid	WHITE	30 lbs	\$336 pair
	SGP-550N*	8' x 24' x 6' x 6' Box	5½" hex	5mm Braid	WHITE	25 lbs	\$339 pair
	SN-6BLUW*	8' x 24' x 6' x 6' Box	5½" hex	5mm Braid	WHITE BLUE	25 lbs	\$306 pair
	SN-6GRNW*	8' x 24' x 6' x 6' Box	5½" hex	5mm Braid	WHITE GREEN	25 lbs	\$306 pair
	SN-6REDW*	8' x 24' x 6' x 6' Box	5½" hex	5mm Braid	WHITE RED	25 lbs	\$306 pair
	SN-6BLKW*	8' x 24' x 6' x 6' Box	5½" hex	5mm Braid	WHITE BLACK	25 lbs	\$306 pair
	SN-2BLUW*	8' x 24' x 4' x 10'	5½" hex	5mm Braid	WHITE BLUE	30 lbs	\$306 pair
	SN-2GRNW*	8' x 24' x 4' x 10'	5½" hex	5mm Braid	WHITE GREEN	30 lbs	\$306 pair
	SN-2REDW*	8' x 24' x 4' x 10'	5½" hex	5mm Braid	WHITE RED	30 lbs	\$306 pair
SN-2BLKW*	8' x 24' x 4' x 10'	5½" hex	5mm Braid	WHITE BLACK	30 lbs	\$306 pair	
CLUB	SEYL-24NHP*	8' x 24' x 0' x 8'	5½" sq	2.5mm Twist	ORANGE	14 lbs	\$120 pair
	SCN-24*	8' x 24' x 4' x 10'	4" sq	3mm Twist	WHITE	20 lbs	\$179 pair
	SCN-21	7' x 21' x 3' x 8'	4" sq	3mm Twist	WHITE	11 lbs	\$169 pair
	SCN-18	6½' x 18½' x 2' x 6'	4" sq	3mm Twist	WHITE	10 lbs	\$149 pair
	SCN-12	6½' x 12' x 2' x 6'	4" sq	3mm Twist	WHITE	8 lbs	\$139 pair
	SCN-9	4½' x 9' x 2' x 5'	4" sq	3mm Twist	WHITE	6 lbs	\$120 pair
SCN-6	4½' x 6' x 2' x 5'	4" sq	3mm Twist	WHITE	6 lbs	\$110 pair	
YOUTH	SFG-14N	7' x 12' x 1' x 4'	4" sq	2.5mm Twist	ORANGE	6 lbs	\$129 pair
	SMG-8NHP	4' x 8' x 0' x 4'	4" sq	2.5mm Twist	ORANGE	5 lbs	\$39 each
	PSS-612N	6' x 12' x 0' x 31"	4" sq	2.5mm Twist	ORANGE	3 lbs	\$47 each
	PSS-608N	6' x 8' x 0' x 31"	4" sq	2.5mm Twist	ORANGE	2 lbs	\$45 each
	PSS-510N	5' x 10' x 0' x 34"	4" sq	2.5mm Twist	ORANGE	2 lbs	\$43 each
	PSS-406N	4' x 6' x 0' x 24"	4" sq	2.5mm Twist	ORANGE	2 lbs	\$39 each

*Official Size Nets 1y



EASY TRACK™ a jaypro sports product



Easy Track™ Net Clips

- > Rigid plastic clips fit securely and flush into Easy Track™ net attachment system so net won't slip
- > 100 clips in a bag (enough clips for a pair of goals)
- > Available in different colors
- > Retail packaging also available

EC-824	WHITE	1 lb	\$82 bag	3Y
EC-824PK	PINK	1 lb	\$82 bag	3Y
EC-824BK	BLACK	1 lb	\$82 bag	3Y
EC-824RD	RED	1 lb	\$82 bag	3Y
EC-824BL	BLUE	1 lb	\$82 bag	3Y



Hook-and-Loop Closure Strips

Convenient hook-and-loop closure strips secure net without lacing.

SINT-20	Kit of 20 - Fits up to 2" OD tubing	2 lbs	\$35 kit	3Y
SINT-40	Kit of 40 4'6" x 6', 4'6" x 9' or 6'6" x 12' Goals	2 lbs	\$47 kit	3Y
SINT-60	Kit of 60 6'6" x 18'6", 7' x 21' or 8' x 24' Goals	2 lbs	\$57 kit	3Y

Kits will fit a pair of classic club goals.



Hoop-and-Loop Closure

- > Custom cut your own straps
- > Closure roll is 1½" wide x 75' long
- > Enough to fit a pair of official goals

VNS-25
2 lbs \$80 each 3Y



Net Clips

- > Exclusive design - treated steel "money clip"
- > For use with existing pre-drilled 5/16" dia holes
- > 70 clips in a kit (enough for a pair of 8' x 24' goals)
- > Plastic retainers included

SNT-180
\$75 kit 2 lbs 3Y

Same as Net Clips (SNT-180) except with:
> Self-drilling screws for aluminum goals
> Space at 14"

SNT-200 2 lbs \$70 kit 3Y



Net Pegs

- > Prevent balls from passing under net

NP-25
Set of 25 3 lbs 3Y
\$42 set







Field Accessories





Disk Cone (Single)

- > Lightweight marker for practice and drills
- > Highly visible and won't tip over
- > 2¼" tall with a 7½" dia base
- > Available in 4 colors

D272BL		1 lb	\$.84 each	3Y	AS
D272OR		1 lb	\$.84 each	3Y	AS
D272RD		1 lb	\$.84 each	3Y	AS
D272YW		1 lb	\$.84 each	3Y	AS

Disk Cone (Set)

> Available in quantities of 100 per set

D272BL-100		15 lbs	\$75 set		3Y	AS
D272OR-100		15 lbs	\$75 set		3Y	AS
D272RD-100		15 lbs	\$75 set		3Y	AS
D272YW-100		15 lbs	\$75 set		3Y	AS



Training Cone

- > Solid plastic stackable cone with perimeter base
- > Bright orange for high visibility
- > Available in 2 heights

D171	9" Cones	1 lb	\$1.80 each	3Y	AS
D175	12" Cones	1.5 lbs	\$3.30 each	3Y	AS



Disk Package

- > Disk Cone Carrier (DCC7)
- > 30 Disk Cones (D272) of each color
- > Colors include blue, orange, red and neon yellow
- > 120 cones in package

DCPKG 20 lbs \$87 package **3Y** **AS**



Disk Cone Carrier

- > Durable white vinyl-coated 5mm steel frame
- > Holds up to 200 disk cones (not included)
- > Dimensions: 7" dia x 12"H

DCC7
1 lb \$7 each **3Y** **AS**



Field ID Marker

- > 14" x 14" vinyl marker with corner grommets
- > Place on back of net of each goal
- > Net attachments not included
- > Specify color and numbers when ordering

FIM-14 1 lb \$29 each **3Y**





Corner Flags

- > Use indoor/outdoor or on turf
- > Official 5' tall x 1" dia PVC poles
- > Set includes 4 poles, 4 flags and 4 black rubber bases

RBF-4
\$225 set

34 lbs
3Y AS



Coaching Sticks

- > Use indoor/outdoor or on turf
- > Official 5' tall x 1" dia PVC poles
- > Each base weighs over 7 lbs
- > 6 poles and 6 black rubber bases in a set

RBCS-6
\$269 set

50 lbs
3Y AS



DCF-251

DCF-255

Deluxe Corner Flags

- > 60" tall x 3/4" thick PVC poles
- > Heavy-duty base and square red/white flag
- > 4 flags in a set

DCF-251
\$89 set

7 lbs
3Y

Deluxe Training Flags

Ideal for training drills and as safety corner flags.

- > Spring loaded base
- > 4 flags in a set

DCF-255
\$99 set

7 lbs
3Y



Flag Base Bag

- > Vinyl carry bag holds 4 rubber bases
- > Dimensions: 2"W x 12"D x 14"H

RBF-BASE 3 lbs
\$30 each 3Y



Soccer Shelters



NOVA™ Team Shelter

Used extensively in Europe, team shelters not only provide refuge from the elements, but the sleek look of European styling adds class to any sport facility and a boost to the morale of any program.

- > Unbreakable tinted polycarbonate
- > Heavy-duty extruded aluminum frame
- > Available in five different widths
- > 8½" pneumatic wheels only on 8', 12' and 16' widths
- > 6'10" tall x 4'8" deep base
- > Ground anchors included
- > Natural finish anodized aluminum bench
- > Add team colors to your bench at no extra cost (specify colors when ordering)
- > Call for details and pricing to add team colors or customized graphics to your shelter
- > Call for freight quote

FR 3Y

DARK GREEN	LIGHT BLUE	YELLOW GOLD
KELLY GREEN	ROYAL BLUE	OLD GOLD
NAVY BLUE	RED	GRAY
BLACK	WHITE	MAROON
PURPLE	ORANGE	

Item	Description	Persons	Price
NTS-8	8' Team Shelter with Seat	5	\$2,739 each
NTS-12	12' Team Shelter with Seat	8	\$3,599 each
NTS-16	16' Team Shelter with Seat	10	\$5,049 each
NTS-20	20' Team Shelter with Seat	13	\$6,299 each
NTS-24	24' Team Shelter with Seat	16	\$7,449 each

Bleachers • Player Benches • Enclosures



See page 120-121 for details about Jaypro Sports player and spectator seating.





Soccer Shelter

- > Powder coated steel frame
- > Removable polyester top for quick and easy (dis)assembly
- > Wheel kit included
- > 4 auger stakes for grass or 4 sand bags (filled in the field) for turf anchoring (specify when ordering)
- > Available in 7 colors
- > See page 120-121 for optional player benches
- > Dimensions: 17'W x 6'4"H x 5'D

SCSHLT-(X)

\$2,995 each



SCSHLT-G

GRAY

SCSHLT-NB

NAVY BLUE

SCSHLT-B

ROYAL BLUE

SCSHLT-R

RED

SCSHLT-BK

BLACK

SCSHLT-M

MAROON

SCSHLT-GR

GREEN

Upgrade your shelter with any of the following options:

Shelter Wind Flap

- > Flaps add protection from wind and rain
- > 17' x 2' mesh fabric sewn into cover with wind flap added to rear of shelter

SCSHLT-WF

\$549 each



2' x 2' Team Logo

- > Sewn on side panel

SCSHLT-LOGO22

\$125 each



3" Team Lettering

- > Letters are sewn across front panel

SCSHLT-LTR

\$99 each



4' x 4' Team Logo

- > Sewn on rear panel

SCSHLT-LOGO44

\$225 each



Vector files required for team logos. Other file formats requires an art charge. Call customer service for additional options.



Referee/Scorekeeper Shelter

- > Powder coated steel frame
- > Removable polyester cover
- > Easy to move and assemble
- > Same lettering and logo options listed above are offered
- > Dimensions: 8½' x 6½' x 4'8"
- > Call for freight quote

RSHLT-(X)

\$1,849 each



RSHLT-G

GRAY

RSHLT-NB

NAVY BLUE

RSHLT-B

ROYAL BLUE

RSHLT-R

RED

RSHLT-BK

BLACK

RSHLT-M

MAROON

RSHLT-GR

GREEN



www.jaypro.com
T: 800-243-0533

F: 800-988-3363

Soccer/Football Combo Goals



Deluxe Official Soccer/Football Goal

Ideal for multi-purpose athletic facilities.

- > NFHS compliant
- > Durable combination of official soccer and football goals
- > Designed for permanent or semi-permanent installation
- > 4" OD round extruded aluminum soccer uprights and crossbars
- > Reinforced corners for extra strength
- > 2" OD removable soccer backstays
- > 2 3/8" aluminum football uprights
- > Powder coated white
- > Nets, post padding and ground sleeves sold separately
- > Soccer Dimensions: 8' x 24' x 10' x 4'
- > Football Uprights: 10' tall

FBSC-240 Goal w/ Standard Backstays
500 lbs \$4,299 pair **FR** **3Y** **★** **X**

FBSC-240EB Goal w/ European Backstays
470 lbs \$4,399 pair **FR** **3Y** **★** **X**



Features Jaypro Sports flush mount Easy Track™ net attachment system

Aluminum Ground Sleeves

- > Aluminum ground sleeves with locking caps for semi-permanent installation

SGP-445G Set of 4 28 lbs \$499 set **3Y**



Official Soccer/Football Goal

Ideal for shared football and soccer fields.

- > Meets high school regulations for competition football and soccer
- > Designed for permanent or semi-permanent installation
- > Football uprights can be installed at high school (23'4") or collegiate (18'6") widths and removed for soccer play
- > 2" x 4" goal support uprights made of 14 gauge steel tubing
- > 2" square steel tube football uprights are 10' tall
- > "Money Clip" style attachments included
- > Powder coated white over a zinc rich primer
- > Nets and backstays sold separately
- > Ground sleeves (SGP-722G) optional
- > Soccer Dimensions: 8' x 24'

Goal (without Backstays)

- > Recommended Portable Combo Goal Net (SEYL-24NHP) sold separately

FBSC-120 650 lbs \$2,995 pair **FR** **3Y** **★**



Standard Backstay Kit

- > Removable soccer backstays made from 1.66" OD galvanized steel tubing
- > Recommended standard official size net (8' x 24' x 4' x 10') sold separately

FBSC-120FBS Set of 4 140 lbs \$665 set **FR** **3Y** **★**

European Backstay Kit

- > Removable European backstays made from 1.66" OD galvanized steel tubing with 4' depth
- > Recommended standard official size net (8' x 24' x 4' x 10') sold separately

FBSC-120EBS Set of 4 45 lbs \$695 set **FR** **3Y** **★**

Ground Sleeves

- > Optional 24" ground sleeves for semi-permanent installation
- > 4 ground sleeves and 4 locking caps included

SGP-722G 15 lbs \$515 set **3Y**



www.jaypro.com
T: 800-243-0533 F: 800-988-3363



Portable Practice Football/Soccer Combo Goal (High School)

Ideal for multi-purpose or practice fields.

- > Lightweight and stable
- > 2" OD galvanized steel construction
- > Double no-flat wheels for easy transport
- > Available in two colors (specify when ordering)
- > Net and wind streamers sold separately
- > Soccer Dimensions: 8' x 24'
- > Football Crossbar: 23'4" wide

PCG-800

400 lbs \$1,995 each **FR** **3Y** **★** **X**

PNT-1

White or Yellow Powder Coat \$150 each

Portable Combo Goal Net

- > 2.5mm orange polyethylene net with 5½" sq mesh

SEYL-24NHP 7 lbs \$120 each **1Y**

Portable Practice Football Goal (High School)

- > H-frame with double no-flat wheels
- > Dimensions: 23'4"W x 20'H

PPG-4HS 375 lbs \$1,795 each **FR** **3Y** **★** **X**

Portable Practice Football Goal (Collegiate)

- > H-frame with double no-flat wheels
- > Dimensions: 18'6"W x 20'H

PPG-4C 375 lbs \$1,795 each **FR** **3Y** **★** **X**



H-Frame Football Goal Post

- > Designed for permanent installation
- > 4" OD heavy-walled aluminum tubing
- > Uprights extend 10' above crossbar
- > Powder coated white
- > Dimensions: 23'4"W x 20'H

HFGP-3 400 lbs \$2,395 pair **FR** **3Y** **★**



Official Rugby Goal

- > Designed for permanent installation
- > Official size rugby goal measures 18'-4"W (5.6m) x 32'H (9.8m)
- > Uprights extend 22' above crossbar & made with 4" O.D. Sch 40 aluminum tubing
- > Crossbar is 4" OD 8 gauge aluminum tubing
- > Tough powder coated white finish

RGP-3 580 lbs \$3,895 pair **FR** **3Y** **★**

Rugby Goal Pad

- > Call Customer Service for details

RGP-SQP \$625 each **FR** **3Y** **★**



MAX-1™ Football Goal Post

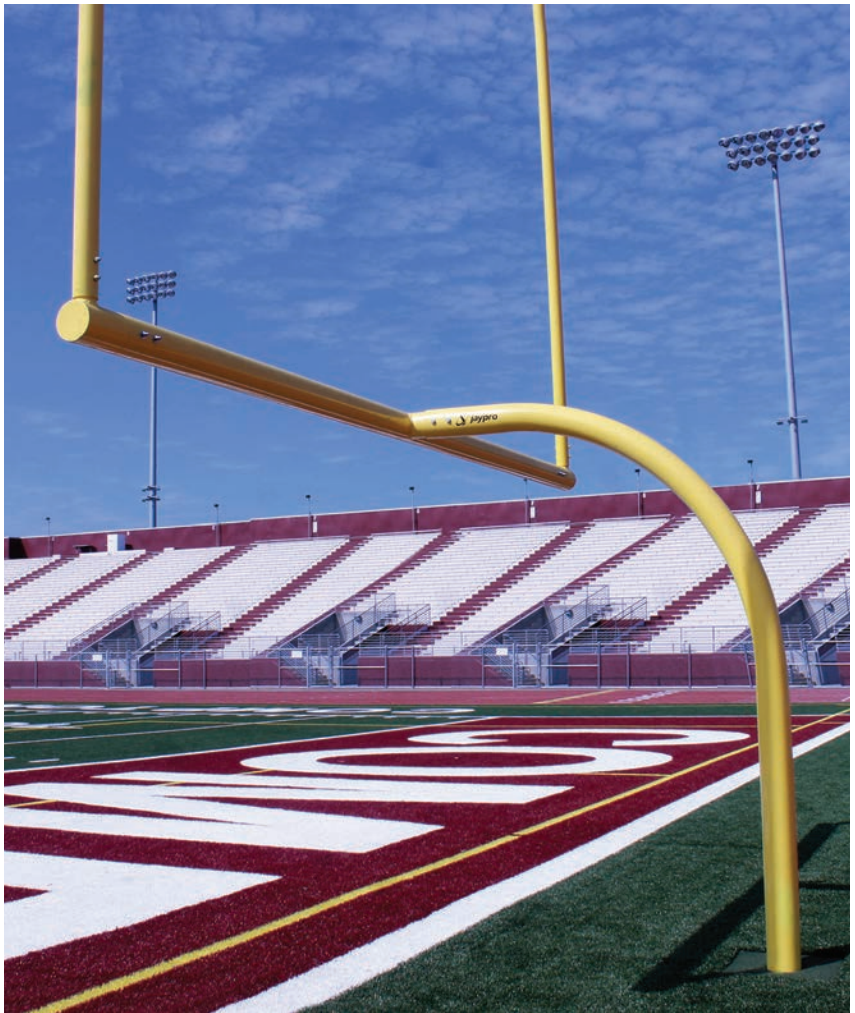

MAX-1™ Aluminum Football Goal Post

- > NCAA and NFHS compliant
- > All aluminum construction
- > Available in high school (23'4") and collegiate (18'6") official sizes
- > 6½" crossbar and gooseneck available with 6' or 8' offset
- > 8' offset perfect for multi-purpose fields and can be used with a soccer goal models SGP-600AX, SGP-400, SGP-760 and CC24S
- > 4" uprights available in 20' or 30' heights
- > Permanent/Semi-Permanent or adjustable leveling plate installation
- > Powder coated white or zinc yellow (specify color when ordering)

See page 47 for ground sleeves, access frames, hinge kits and other accessories.



MAX-1™ Aluminum Football Goal Post

	Offset	Uprights	Semi-Permanent/Permanent Item #	Price	Leveling Plate Item #	Price
High School 23' 4" wide	6'	20'	FBGP-520	\$7,495 pair	FBGP-420	\$8,995 pair
	6'	30'	FBGP-530	\$7,895 pair	FBGP-430	\$9,295 pair
	8'	20'	FBGP-820	\$7,695 pair	FBGP-920	\$9,295 pair
	8'	30'	FBGP-830	\$8,095 pair	FBGP-930	\$9,595 pair
Collegiate 18' 6" wide	6'	20'	FBGP-520C	\$7,395 pair	FBGP-420C	\$8,895 pair
	6'	30'	FBGP-530C	\$7,795 pair	FBGP-430C	\$9,195 pair
	8'	20'	FBGP-820C	\$7,595 pair	FBGP-920C	\$9,195 pair
	8'	30'	FBGP-830C	\$7,995 pair	FBGP-930C	\$9,495 pair

MAX-1™ Expandable Crossbar

- > Telescoping design adjusts crossbar width for official use at 23'4" (high school) and 18'6" (college)
- > Anti-rotation feature holds uprights in place allowing adjustment by one person

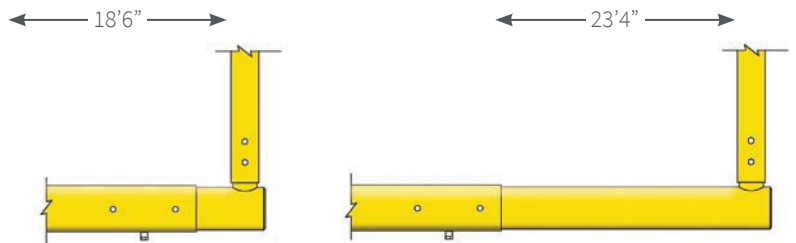

MAX-1™ Expandable Crossbar

	Offset	Uprights	Semi-Permanent/Permanent Item #	Price	Leveling Plate Item #	Price
Expandable 18' 6" - 23' 4" wide	6'	20'	FBGP-520AX	\$8,695 pair	FBGP-420AX	\$9,995 pair
	8'	20'	FBGP-820AX	\$8,895 pair	FBGP-920AX	\$10,295 pair

Steel Football Goal Post

- > NCAA and NFHS compliant
- > Zinc and powder coated steel gooseneck
- > Available as 4½" with 5' offset or 5⅞" with 6' offset
- > 2⅜" top aluminum uprights
- > Adjustable in two directions ensuring crossbar and uprights are level and plumb
- > Permanent or adjustable leveling plate installation options
- > Ground sleeves for semi-permanent installation sold separately

See pages 45 and 47 for accessories.



Adjustable in two directions

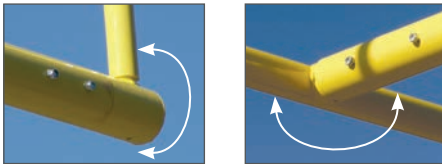

Semi-Permanent
Permanent

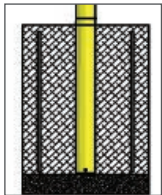

Leveling Plate

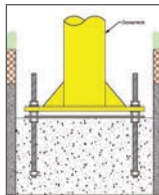

Steel Football Goal Post

High School
23' 4" wide

Offset	Uprights	Color	Gooseneck	Semi-Permanent/Permanent Item #	Price	Leveling Plate Item #	Price
5'	20'	Yellow	4½"	FBGP-620YW	\$4,295 pair	FBGP-600YW	\$5,295 pair
5'	20'	White	4½"	FBGP-620	\$4,295 pair	FBGP-600	\$5,295 pair
5'	30'	Yellow	4½"	FBGP-630YW	\$4,695 pair	FBGP-635YW	\$5,695 pair
5'	30'	White	4½"	FBGP-630	\$4,695 pair	FBGP-635	\$5,695 pair
6'	20'	Yellow	5⅞"	FBGP-720YW	\$6,295 pair	FBGP-700YW	\$6,995 pair
6'	20'	White	5⅞"	FBGP-720	\$6,295 pair	FBGP-700	\$6,995 pair

Collegiate
18' 6" wide

6'	20'	Yellow	5⅞"	FBGP-720XCYW	\$5,695 pair	FBGP-700CYW	\$6,395 pair
6'	20'	White	5⅞"	FBGP-720C	\$5,695 pair	FBGP-700C	\$6,395 pair



Ground Sleeves with Height Adjuster

- > Adjustable ground sleeves
- > Easy alignment



FBGPGS-5	4½" dia	250 lbs	\$895 pair
FBGPGS-6	5⅞" dia	275 lbs	\$995 pair



Standard Ground Sleeves

FBSLV5	4½" dia	200 lbs	\$795 pair
FBSLV6	5⅞" dia	225 lbs	\$845 pair



Netting & Indoor Football



FieldPro™ Football Ball Stop System

Ideal for keeping field goals and extra point kicks inside the field.

- > 30' or 40' height options
- > 40' wide net easily raises and lowers with a rope and marine style swivel pulley system with integrated ball bearings
- > #36 knotted black nylon net with 3½" sq mesh and ¼" rope border
- > 6⅝" dia aluminum poles (powder coated black if requested)
- > Ground sleeves and hardware included

See pages 111-113 for more FieldPro™ Net System options.

FNFB-30	40'W x 30'H	530 lbs	\$4,295 each
FNFB-40	40'W x 40'H	762 lbs	\$6,695 each

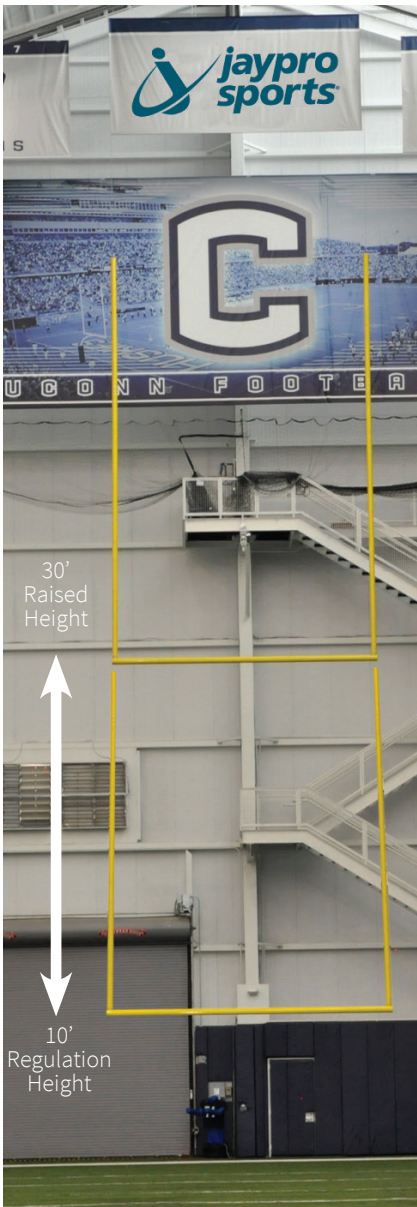
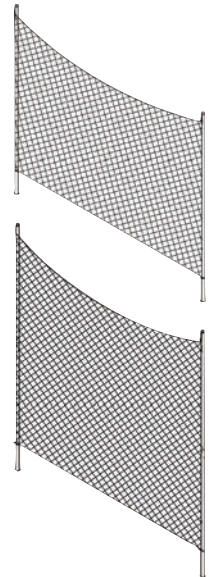

30'
Raised
Height

10'
Regulation
Height

UConn's Shenkman Training Center

Ceiling Suspended Football Goal Post

Ideal for indoor practice facilities.

- > Suspended directly beneath building structure
- > Attaches directly to rigid frame girders, building trusses, I-beams or roof purlins
- > 6⅝" OD aluminum crossbar is 18'6" wide
- > 4" OD aluminum uprights are 30' tall
- > 20' uprights available
- > Crossbar leveling feature included
- > All attachment and suspension hardware included

CSGP-1	390 lbs	Call for Pricing
---------------	---------	------------------



Retractable Ceiling Suspended Football Goal Post

Ideal for indoor practice facilities.

- > 1 HP electric hoist system raises goal post out of way when not in use
- > Suspended directly beneath building structure
- > Attaches directly to rigid frame girders, building trusses, I-beams or roof purlins
- > 6⅝" OD aluminum crossbar is 18'6" wide
- > 4" OD aluminum uprights are 30' tall
- > 20' uprights available
- > Crossbar leveling feature included
- > All attachment and suspension hardware included

CSGP-2	510 lbs	Call for Pricing
---------------	---------	------------------

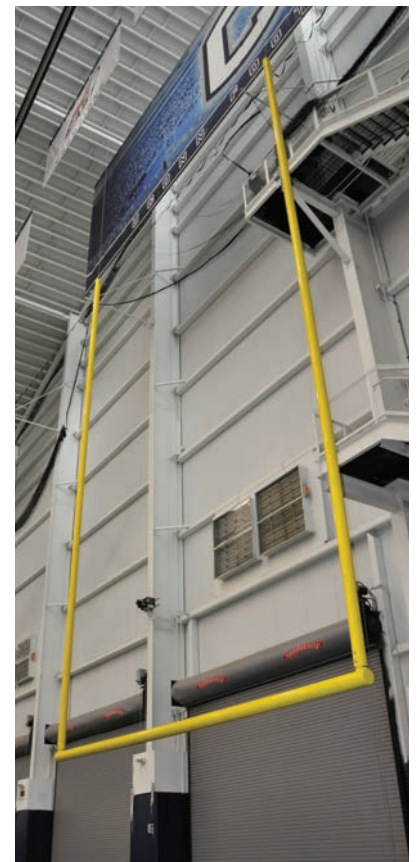

www.jaypro.com
T: 800-243-0533 F: 800-988-3363

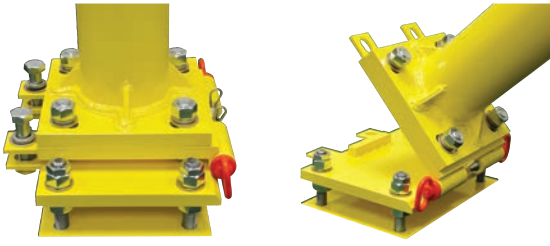

Football Hinge Kit

Ideal for multi-purpose facilities.

- > Allows any surface-mounted MAX-1™ football goal to be lowered and dismantled from ground level by a maintenance crew
- > Opposing pull pins offer easy separation of hinge plates
- > Welded shackle bracket on the MAX-1™ football gooseneck offers attachment point for cable or hoist
- > Required access frame and cover (FBGPAF-2) sold separately

FBHG-1 60 lbs \$729 each **3Y** ★



Access Frame and Cover

- > For use with semi-permanent goals requiring removal from grass or turf fields
- > Constructed of aluminum, pressure-treated plywood and artificial turf
- > Turf cover hides anchoring hardware and allows access when required
- > 2 split panels for use with post and 2 full panels for use when post is removed
- > 2 frames and 4 turf covered plates included
- > Available in two sizes

FBGPAF-1 18¼"W x 18¼"L x 8"H (for use with FBSLV8)
60 lbs \$1,299 pair **3Y** ★

FBGPAF-2 29"W x 29"L x 11 5/8"H (for use with FBHG-1)
60 lbs \$1,499 pair **3Y** ★

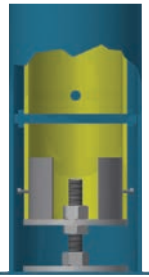

Ground Sleeves with Height Adjuster

For MAX-1 goal posts

- > Adjustable ground sleeves
- > Easy alignment

FBGPGS-8 6½" dia 300 lbs \$1,159 pair **FR** **3Y** ★



Standard Ground Sleeves

For MAX-1 goal posts

FBSLV8 6½" dia 250 lbs \$905 pair **FR** **3Y** ★



Soccer/Football Anchor Kit

- > Fastens the soccer goal rear crossbar to a football goal gooseneck

SFGA-6 6½" OD Gooseneck 10 lbs \$120 each

SFGA-5 5½" OD Gooseneck 10 lbs \$130 each

SFGA-4 4½" OD Gooseneck 10 lbs \$140 each

3Y ★



Wind Streamers

- > 4"W x 42"L streamers with grommets

WS-42 2 lbs \$25 pair **3Y** ★



Pro Style Protector Pad

- > Designed for different round goal post sizes
- > 6'H x 6" thick foam covered by 14 oz vinyl
- > Hook-and-loop attachment included
- > See chart for vinyl colors

PPP-500 **FR** **3Y** ★
4½" OD Post 35 lbs \$769 pair

PPP-700 **FR** **3Y** ★
5½" OD Post 40 lbs \$825 pair

PPP-800 **FR** **3Y** ★
6½" OD Post 45 lbs \$1,025 pair

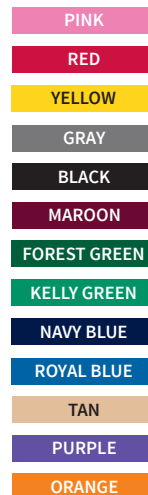

Economy Post Protector Pad

- > 6'H x 4" thick foam covered by 14 oz vinyl
- > Grommet attachment and cord included
- > See chart for vinyl colors

PPP-5 **FR** **3Y** ★
4½" OD Post 18 lbs \$429 pair

Custom Lettering

Get your school and/or team name in white lettering on your protector pad.

PVL-39
White Lettering 1 lb \$159 pad



Portable Press Box & Field Accessories



Portable Press Box

Ideal for coaching, filming, and press media.

- > All aluminum construction
- > Weather-resistant canvas top
- > Bench moves forward and backward
- > 16" pneumatic wheels (2 lockable and 2 swivel)
- > Canvas enclosure for inclement weather and tow kit sold separately
- > See chart for canvas colors (specify when ordering)
- > 5'9" platform height
- > 4' x 10'6" platform area
- > Overall Dimensions: 7' x 10'6"
- > Call for freight quote

PPB-5 Portable Press Box
1,380 lbs \$13,995 each **FR** **3Y** ★

PPB-SC Removable Side Curtains/Enclosure
50 lbs \$1,395 each **3Y** ★

PPB-TOW Tow Bar/Kit
50 lbs \$435 each **3Y** ★

LIGHT BLUE	YELLOW GOLD	BLACK
ROYAL BLUE	TAN	NAVY BLUE
RED	GRAY	KELLY GREEN
WHITE	MAROON	DARK GREEN
ORANGE	PURPLE	



Crushable Sideline Markers

- > Self-standing with weighted bottom
- > 12" tall numerals on both sides
- > Heavy-duty cover
- > Stores flat
- > Call for freight quote

FBWSM 11 Piece Set 32 lbs \$329 set **1Y**



Chain Set

- > Completely padded bright orange targets
- > Plated chain and swivel hooks eliminate kinks and knots
- > Available in 2 sizes
- > Call for freight quote

FCS-8 8' Height
19 lbs \$345 set **1Y**

FCS-7 7' Height
15 lbs \$229 set **1Y**



Flip Down Indicator

- > Completely padded
- > Durable numbers
- > Call for freight quote

FFD-10
12 lbs \$229 each **1Y**

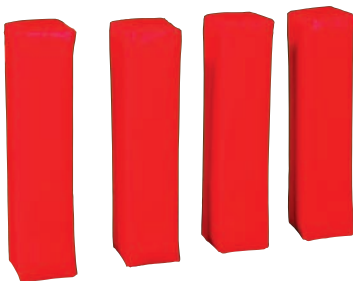

Free Standing Pylons

- > Self-standing end zone pylon with weighted bottom
- > Anchorless
- > Dimensions: 4"W x 4"L x 18"H
- > Call for freight quote

FBPYLN 4 Piece Set
12 lbs \$49 set **1Y**



Football Equipment Storage Rack Package

- > 1 StackMaster™ Shoulder Pad Rack (SP4)
- > 1 StackMaster™ Helmet Rack (H-1)

FRP-2 128 lbs \$439 package



Football Storage Equipment

STACKMASTER™ a **jaypro sports** product



Stackmaster™ Shoulder Pad Rack

- > Transport and store up to 42 shoulder pads
- > 1⁵/₁₆" OD steel frame
- > Heavy-duty non-marking swivel wheels
- > Dimensions: 2'W x 6'6"H

SP-2 37 lbs
\$215 each  **3Y**

Stackmaster™ Deluxe Shoulder Pad Rack



- > Transport and store 60-80 shoulder pads
- > All steel frame with removable transport handle
- > Heavy-duty non-marking swivel wheels
- > Dimensions: 24"W x 60"L x 70"H

SP4 78 lbs
\$299 each  **3Y**



Stackmaster™ Helmet Rack

- > Transport and store up to 56 helmets
- > All-welded steel base
- > Heavy-duty non-marking swivel wheels
- > Dimensions: 2'6"W x 6'3"H

H-1 71 lbs
\$245 each  **3Y**

Stackmaster™ Deluxe Helmet Rack



- > Transport and store up to 60 helmets with masks
- > Can also be used for lacrosse and baseball batting helmets
- > 1" OD chrome steel tubing
- > Heavy-duty non-marking swivel wheels
- > Fits through a standard doorway
- > Dimensions: 24"W x 61"L x 64"H

FHC-1 115 lbs
\$289 each  **3Y**



Football Training



Lowdown Linemen Chute

Ideal for training linemen and backers to stay low and to run blocking schemes and trap drills.

- > Heavy-walled steel upper frame reinforced for stability
- > Lightweight aluminum lower frame is chain suspended and fully padded
- > Easily adjust height from 42" to 66" with telescoping legs and angle position with support chains
- > Lightweight black weather-resistant mesh fabric screen won't scratch player helmets
- > 12" heavy-duty pneumatic swivel wheels
- > Open access from all sides
- > Available in 2 sizes

FBLC-20	6'W x 20'L	450 lbs	\$3,395 each	FR		3Y	★	X
FBLC-30	6'W x 30'L	500 lbs	\$4,395 each	FR		3Y	★	X



Linemen Chute

Ideal as an instruction tool to teach the basics of coming off the ball low and drive upward.

- > Adjustable entrance with three height positions
- > 1 5/8" heavy-duty steel tube frame with pin stop adjustment
- > Chutes can be attached to each other to replicate entire line
- > Dimensions: 5'W x 4'L x 40"-50"H

FBLMCH	47 lbs	\$179 each		3Y
---------------	--------	------------	--	----



Professional Portable Kicking Cage

Ideal for warm-up exercises.

- > 1 5/16" heavy-duty galvanized steel frame
- > Durable knotless nylon kicking net helps contain balls
- > Folds down for convenient storage
- > Black Cordura carry bag included
- > Dimensions: 48"W x 86"H x 48"D

PKC-1	39 lbs	\$489 each		3Y
--------------	--------	------------	--	----

Replacement Net

PKC-1N	5 lbs	\$135 each		1Y
---------------	-------	------------	--	----



Portable Kicking Cage

- > 1 1/2" powder coated frame with 26 lb weighted base
- > Heavy-duty slip-on nylon net included
- > Easy assembly without tools
- > Dimensions: 4'W x 6'6"H

PK-64	35 lbs	\$175 each		3Y
--------------	--------	------------	--	----



Football Training Package

- > Linemen Chute (FBLMCH)
- > High Stepper Agility Trainer (FBHSTP)
- > Portable Kicking Cage (PK-64)

FBTP-3 \$525 package 3Y

Round

Curved

Step Over



Round Stand-Up Blocking Dummy

- > Self-standing with dense foam core
- > Double reinforced 18 oz coated vinyl cover with double web belt handles for sure grip
- > Replaceable lace bottom for extended life
- > Available in 3 sizes
- > See chart for vinyl colors (specify when ordering)
- > Call for freight quote

FBSUD38	14" dia x 38"H	13 lbs	\$125 each	
FBSUD42	14" dia x 42"H	16 lbs	\$135 each	
FBSUD48	13" dia x 48"H	18 lbs	\$145 each	

Curved Pro Body Shield

- > Pre-curved 4" thick dense foam core
- > Double reinforced coated vinyl cover with web handles
- > See chart for vinyl colors (specify when ordering)
- > Call for freight quote

FBPRCRV 24" x 16" x 4" 4 lbs \$72 each

Step Over Agility Dummy

- > Dense foam core
- > Double reinforced 18 oz coated vinyl cover
- > Back side handles for stand up practice
- > Available in 2 sizes
- > See chart for vinyl colors (specify when ordering)
- > Call for freight quote

FBST8	48" x 8" x 17"	11 lbs	\$159 each	
FBST12	48" x 12" x 17"	13 lbs	\$199 each	



High Stepper Agility Trainer

Ideal for building foot speed and agility.

- > Steel tube frame with suspended rope running a 16 square grid
- > 5 adjustable heights to increase leg lift
- > Frame located outside of running grid area for safety
- > Quick and easy assembly
- > Dimensions: 6'W x 20'L

FBHSTP 45 lbs \$239 each 3Y



SackBack Tackle Sled

- > Durable round steel frame
- > 100 lb impact-resistant foam with 18 oz vinyl cover
- > Round, cone and attack style pads available (specify when ordering)
- > See chart for vinyl colors (specify when ordering)
- > Call for freight quote 1Y

TKSLDV Varsity	225 lbs	\$1,059 each
TKSLDP Pro	295 lbs	\$1,259 each



Snap Attack Football Machine

Maximize time on the most difficult to practice phases of the game. See page 81 for details about this product.

SAFM-1 165 lbs \$4,199 each 1Y



National Lacrosse Goal



NLL Box Lacrosse Goal

Ideal for professional box lacrosse leagues.

- > Official goal of the National Lacrosse League
- > All welded front face attached to a heavy weighted backstay
- > 2" OD thick-walled steel frame
- > 4"W x 3/8"H base plate
- > Net attaches to goal face via 3/8" net rail and is anchored securely along the bottom with an innovative flat cover plate
- > Flat cover plate can display logos and sponsors
- > Net (NLLN-PX1) sold separately
- > Dimensions: 4'9"W x 4'H x 4'D

NLL-PX1	Goal				
150 lbs	\$819 each	FR	●	3Y	★ X
NLLN-PX1	Replacement Net				
10 lbs	\$279 each				1Y

Display logos and sponsors on flat cover plate



Official Goal of the National Lacrosse League



The NLL team logos on this page are trademarked and owned and licensed by the NLL and may not be reproduced without its written consent.



new
Lacrosse Goal Transport Cart

Moving lacrosse goals in the field is made easy with this transport cart.

- > Hold-down straps secure goal to cart
- > Vinyl coated handle and rubber base pads protect lacrosse goal finish
- > 3" x 1/4" angle heavy-duty steel base construction
- > 1.315" heavy-walled steel pipe handle
- > 10" no-flat tires
- > Powder coated black
- > Adjustable cart fits multiple sized goals up to 6'8" wide

LG-HT	\$499 each	★
--------------	------------	---



Official Lacrosse Goal Package

- > 2 Official Lacrosse Goals (LG-50)
- > 2 Competition Lacrosse Nets (LGN-50)

LG-50PKG					
190 lbs	\$869 package	FR	●	3Y	1Y

Box Lacrosse Goal



Official Box Lacrosse Goal

Ideal for 6 vs 6 play.

- > Official 4' x 4' size
- > Indoor use
- > Rust-proof zinc coated steel
- > 2" OD steel frame with mitered and welded corners
- > Net attaches to goal face/bottom via 1/4" steel net rail
- > 3mm knotless polyester net with 1 1/2" sq mesh and lacing cord included
- > Dimensions: 4'W x 4'H x 4'D

LG-44B Goal & Net 49 lbs \$249 each

Replacement Nets (4'W x 4'H x 4'D)

LGN-44 4mm knotless polyester 1 1/2" sq mesh White 6 lbs \$75 each
LGN-44X 6mm knotless polyester 1 1/2" sq mesh White 7 lbs \$95 each

Official Lacrosse Goals



Deluxe Field Lacrosse Goal

Ideal for high-end and collegiate play and designed with the NLL Box Lacrosse Goal safety features.

- > Official 6' x 6' size
- > All welded front face attached to a heavy weighted backstay
- > 2" OD thick-walled steel frame
- > 4"W x 3/8"H base plate
- > Net attaches to goal face via 3/8" net rail and is anchored securely along the bottom with an innovative flat cover plate
- > Flat cover plate can display logos and sponsors
- > Nets (LGN-50, LGN-30, LGN-25) sold separately
- > Dimensions: 6'W x 6'H x 7'D

LG-1X 180 lbs \$1,699 pair



Official Lacrosse Goal

Ideal for men's lacrosse leagues.

- > Official 6' x 6' size
- > Meets NCAA and NFHWS requirements for men's lacrosse
- > Rust-proof zinc coated steel pipe
- > 2" OD steel pipe frame for full NCAA compliance
- > Mitered and welded corners
- > Net attaches to goal face/bottom via 1/4" net rail for a professional appearance
- > Rear brace sits flat on the ground to eliminate ball obstruction
- > Nets (LGN-50, LGN-30, LGN-25) sold separately
- > Dimensions: 6'W x 6'H x 7'D

LG-50 170 lbs \$649 pair

LG-50HP 85 lbs \$399 each



Practice Lacrosse Goal

Ideal for home or practice fields.

- > Official 6' x 6' size
- > 1 3/4" OD steel frame
- > 3.5mm net included
- > Net pocket slides under backstay for secure fit
- > Dimensions: 6'W x 6'H x 7'D

LG-540 38 lbs \$199 each



Lacrosse Nets & Accessories

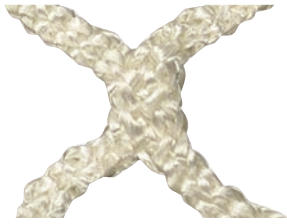

Competition Lacrosse Net

- > Meets NCAA and NFHS regulations
- > 6mm knotless net with 1½” sq mesh
- > Weatherproof white polyester with natural UV stabilizer
- > Triple stitched webbing binder
- > Lacing cord included
- > Dimensions: 6’W x 6’H x 7’D

LGN-50 15 lbs \$125 each **1Y**



Official Lacrosse Net

- > Meets NCAA and NFHS regulations
- > 4mm knotless net with 1½” sq mesh
- > Weatherproof white polyester with natural UV stabilizer
- > Triple stitched webbing binder
- > Lacing cord included
- > Dimensions: 6’W x 6’H x 7’D

LGN-30 13 lbs \$105 each **1Y**



Practice Lacrosse Net

- > Official size
- > 3.5mm knotless net with 1½” sq mesh
- > Lacing cord included
- > Replacement net for LG-540 or tubular style goals without net rail
- > Dimensions: 6’W x 6’H x 7’D

LGN-25 6 lbs \$79 each **1Y**



Lacrosse Rebounder

Ideal for working on shots and passes.

- > Durable steel tube frame
- > Easily adjust angle of target
- > Target Area: 3’W x 4’H
- > Dimensions: 4’W x 8’H

LAX-RBD
65 lbs \$199 each **3Y**



Lacrosse Training Net

Ideal for improving shooting accuracy.

- > Fits any 6’ x 6’ goal
- > Attaches to goal face
- > Carry bag included

LAX-TN 5 lbs \$69 each **1Y**



Field ID Markers

- > Vinyl markers available in many colors
- > Corner grommets allow for attachment to back of goal net
- > Net attachments not included
- > Specify vinyl color and numbers needed when ordering
- > Dimensions: 14”W x 14”H

FIM-14 1 lb \$29 each **1Y**

FieldPro™ Multi-Sport Net System

Stop wasting time chasing missed shots or errant passes during practice and games. Ensure the safety of athletes, coaches and spectators. This ball stop net system is ideal for lacrosse and other field sports.

See page 111 for details about this product.

FNMB-65
\$2,350 each

FR **3Y** **1Y**





Official Field Hockey Package

- > 1 Pair Official Field Hockey Goals (OFHG7124)
- > 1 Pair Official Field Hockey Nets (FHND-8)
- > 1 Wheel Kit (FHGWK)

OFHG7124PKG

602 lbs \$2,825 package

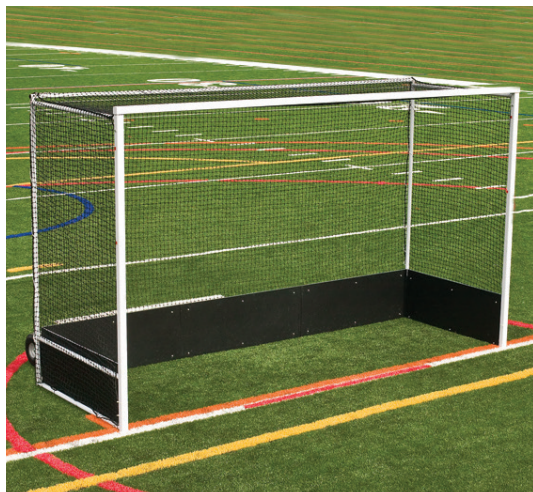

Official Field Hockey Goal

- > Meets official NCAA, NFHS and FIH specifications
- > Heavy-duty 2" square steel goal face
- > 1 5/16" OD galvanized steel rear frame
- > All welded side frames and top rear crossbar for maximum stability
- > Available with or without official 1/2" thick high density polyethylene black bottom boards that never fade or break
- > Unique "money clip" style net clips (SNT-180) simplify net attachment
- > Nets (FHND-8) sold separately
- > Optional wheel kit (FHGWK) sold separately
- > Dimensions: 12'W x 7'H x 4'D

OFHG7124

with Bottom Boards 534 lbs \$2,549 pair



OFHGNBB

without Bottom Boards 370 lbs \$1,465 pair

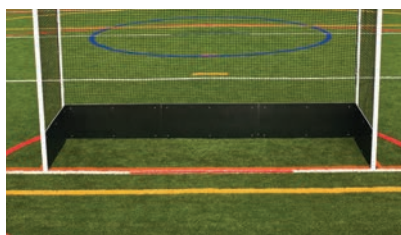

Official Bottom Boards

- > Fits most field hockey goals
- > 1/2" thick high density polyethylene
- > Never fade or break
- > Hardware included

FHG-16

140 lbs \$1,049 pair



Wheel Kit

Optional "tip & roll" wheel kit makes goals easy to transport.

- > 4 heavy-duty 10" no flat wheels
- > Set modifies 1 pair of goals

FHGWK

49 lbs \$469 set

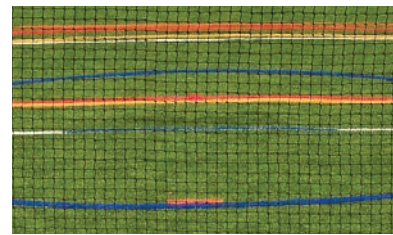

Official Field Hockey Net

- > Weatherproof 1 3/4" sq mesh
- > 2.5mm polyethylene material
- > Dimensions: 12'W x 7'H x 4'D

FHND-8

19 lbs \$209 pair



Practice Field Hockey Goal

- > Official size
- > 1 5/16" OD galvanized steel frame
- > Cast aluminum corner fittings for easy assembly
- > Net (black) included
- > Dimensions: 12'W x 7'H x 4'D

PFHG-41

63 lbs

\$495 each



Batting Cages



Shown with optional ricochet padding upgrade kit

Big League Portable Batting Cage

- > 2" heavy-duty Schedule 40 aluminum tube construction
- > #42 black climatized nylon net with rear net baffle
- > 4' x 6' x 4" thick thud pad, vinyl skirt and standard black ricochet padding on all overhead framing
- > Dual coach stands with leaning bar also serves as a convenient strut holder
- > Oversized 18" dia x 8"W pneumatic side wheels
- > Rear wheel handle can be lifted or lowered to move cage
- > Optional Tow Hitch (BL-TOWKIT) sold separately
- > Open Dimensions: 18'W x 12'H x 22'D
- > Folded Dimensions: 18'W x 5'H x 12'D

BGLC-7500RB	ROYAL BLUE	600 lbs
BGLC-7500BK	BLACK	
BGLC-7500RD	RED	FR 3Y 1Y X
BGLC-7500GR	GREEN	
BGLC-7500NB	NAVY BLUE	\$4,897 each

Replacement Net

BLN-3	\$829 each	1Y
--------------	------------	-----------

Oversized Pneumatic Wheels



Rear Wheel Handle



Vinyl Skirt

- > Royal Blue (RB), Black (BK), Red (RD), Green (GR), Navy Blue (NB)

SKT-75XX	30 lbs	\$365 each	3Y
-----------------	--------	------------	-----------

Replacement Thud Pad

- > Royal Blue (RB), Black (BK), Red (RD), Green (GR), Navy Blue (NB)

THUD-46XX	20 lbs	\$335 each	3Y
------------------	--------	------------	-----------

Ricochet Padding Upgrade Kit

Ideal for upgrading batting cages with durable vinyl covers.

- > Wraps around ricochet foam padding
- > Hook-and-loop attachment
- > Kit contains (21) 6 foot lengths
- > Royal Blue (RB), Black (BK), Red (RD), Green (GR), Navy Blue (NB)

RPAD-UKITXX	10 lbs	\$299 kit	3Y
--------------------	--------	-----------	-----------

Tow Hitch Conversion Kit

Ideal for towing batting cages with any utility vehicle.

BL-TOWKIT	\$225 each	3Y
------------------	------------	-----------

Optional Tow Hitch Conversion Kit



www.jaypro.com
T: 800-243-0533 F: 800-988-3363



Shown with optional skirt graphics and additional ricochet padding

Grand Slam Portable Batting Cage

Ideal for spring training camps and designed for semi-professional and collegiate use.



- > 2" heavy-walled aluminum tube construction
- > #42 black climatized nylon net with rear net baffle
- > 60' of ricochet cushion reduces rebound and frame damage
- > Rear safety railing for safe viewing by coaches
- > Frame features handy strut holders
- > Folds down to 5' tall for easy storage
- > Heavy vinyl coated nylon skirt protects frame
- > (3) 16" pneumatic turf wheels
- > Optional Coach Stand (CVS-10) sold separately
- > Call for price quote to add graphics on skirt
- > Dimensions: 18'W x 12'H x 22'D

BBGS-18	GREEN	500 lbs	
BBGS-18RB	ROYAL BLUE		FR 3Y 1Y
BBGS-18RD	RED		
BBGS-18NB	NAVY BLUE	\$4,297 each	

Skirt Graphics

Get your team name/logo on a vinyl sticker for your cage skirt.

SKT-LOGO Up to 8'W multi color \$299 each **1Y**

Collapses Easily

Strut Storage



Vinyl Skirt

> Green (GR), Red (RD), Royal Blue (RB), Navy Blue (NB)

SKT-75XX 30 lbs \$365 each **3Y**

Replacement Net

BLN-3 18' x 22' x 12' 75 lbs \$829 each **1Y**

GSN-1 17'6" x 18' x 12' 65 lbs \$829 each **1Y**

Viewing Stand

Ideal for coaches to view batting practice from a convenient adjustable stand attached to the rear of the batting cage.

CVS-10 24 lbs \$499 each **3Y**

Ricochet Cushion

BPD-6 6' lengths 2 lbs \$29 each **3Y**

Weather Resistant Tape

PDT-3 60 yd rolls 2 lbs \$62 each **3Y**

Folds to a compact size



www.jaypro.com
T: 800-243-0533

F: 800-988-3363

Batting Cages



Little Slam Portable Batting Cage

Ideal for high school and collegiate use.



- > 2" heavy-walled aluminum tube construction
- > #42 black climatized nylon net with rear net baffle
- > 24" of ricochet cushion reduces rebound and frame damage
- > Frame features handy strut holders
- > Folds down for easy storage
- > Heavy vinyl coated nylon skirt protects frame
- > (3) wheels
- > Optional Coach Stand (CVS-10) sold separately
- > Vinyl Skirt Colors (SKT-20XX) sold separately
- > Dimensions: 17'6"W x 12'H x 12'D

BBS-12 410 lbs \$3,597 each **FR** **3Y** **1Y**

Vinyl Skirt

SKT-20	GREEN	23 lbs
SKT-20RD	RED	3Y X
SKT-20RB	ROYAL BLUE	
SKT-20NB	NAVY BLUE	



Viewing Stand

Ideal for coaches to view batting practice from a convenient adjustable stand attached to the rear of the batting cage.

CVS-10 24 lbs \$499 each **3Y**

Ricochet Cushion

BPD-6 6' lengths 2 lbs \$29 each **3Y**

Weather Resistant Tape

PDT-3 60 yd rolls 2 lbs \$62 each **1Y**

Replacement Net

LSN-2 55 lbs \$829 each **1Y**

Collapses Easily



Line Drive Cage Net

- > Replacement net for the Line Drive Batting Cage
- > Dimensions: 16'6"W x 12'H x 16'6"D

LDN-5 34 lbs \$749 each **1Y**



www.jaypro.com
T: 800-243-0533 F: 800-988-3363

T: 800-243-0533 F: 800-988-3363

Backstops & Padding



Permanent Baseball/ Softball Backstops

- > 10'W x 12'H upright sections
- > 2 $\frac{3}{8}$ " OD main upright x .095"W galvanized steel
- > 1 $\frac{1}{2}$ " OD crossbars x .085"W galvanized steel
- > 9 gauge smooth galvanized fence fabric
- > 10'W x 6'D overhang section
- > Backstop sections are not prefabricated chain link
- > All galvanized fitting, nuts and bolts
- > Call for freight quote

FR 3Y ★

Item	Description	Weight	Price
BSP-30	3 Panel only	552 lbs/ea	\$1,999
BSP-30-6	3 Panels, 1 Center Overhang	682 lbs/ea	\$2,299
BSP-33-2	3 Panels, 1 Center, 2 Wing Overhangs	860 lbs/ea	\$3,099
BSP-40	4 Panels only	727 lbs/ea	\$2,599
BSP-40-66	4 Panels, 2 Center Overhangs	956 lbs/ea	\$3,399
BSP-44-22	4 Panels, 2 Center, 2 Wing Overhangs	1,134 lbs/ea	\$4,099

See page
110-114 for
details about
Net style
backstops



Backstop Padding

- > 2" thick high-impact foam with grommet flaps on all sides for attachment to chain link fencing
- > 2' folding sections (available in solid or alternating colors)
- > Available in several sizes
- > Eco-friendly padding and optional graphics available (call for details and pricing)
- > See chart for vinyl colors (specify when ordering)
- > Call for freight quote

FR 1Y

Shown with Optional Graphics



Item	Size	Price
BSP236	3' x 6'	\$299
BSP238	3' x 8'	\$309
BSP2310	3' x 10'	\$379
BSP2312	3' x 12'	\$439

Item	Size	Price
BSP246	4' x 6'	\$309
BSP248	4' x 8'	\$379
BSP2410	4' x 10'	\$449
BSP2412	4' x 12'	\$499

SKY BLUE	ROYAL BLUE		
GRAY	TAN	RED	MAROON
WHITE	PURPLE	NAVY BLUE	MAPLE GREEN
BLACK	ORANGE	YELLOW	KELLY GREEN



Field Wall Padding

- > 2" thick high-impact foam on $\frac{3}{4}$ " outdoor water sealed wood ply boarding
- > Available in several sizes
- > Eco-friendly padding and optional graphics available (call for details and pricing)
- > See chart for vinyl colors (specify when ordering)
- > Call for freight quote

FR 1Y



Item	Size	Price
FWP246	4' x 6'	\$375
FWP248	4' x 8'	\$495

Item	Size	Price
FWP2410	4' x 10'	\$645
FWP2412	4' x 12'	\$745



Batting Tunnel Frames



Professional Outdoor Batting Tunnel Frame

- > 4" OD aluminum tubing construction
- > Curved supports provide 3' offset
- > Clean design with less structure for ball to ricochet off
- > Ground sleeves (included) accommodate both 12' and 14' wide nets
- > Individual hoist lines make for easy installation and removal of net
- > Net sold separately

PROTF-70

70'L x 12'H

400 lbs

\$3,995 each

FR 3Y ★

PROTF-55

55'L x 12'H

350 lbs

\$3,795 each

FR 3Y ★

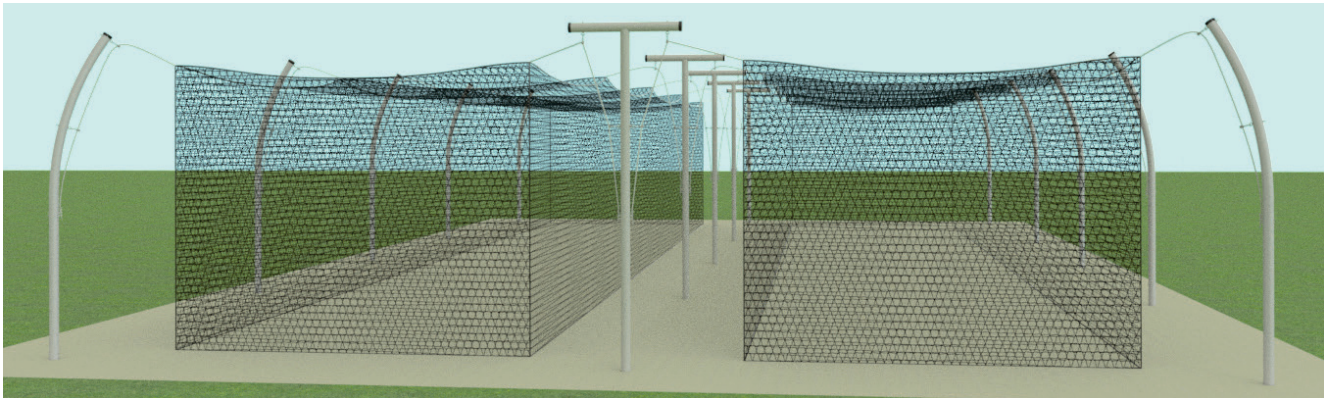

Tandem Professional Outdoor Batting Tunnel Frame

- > Side by side professional style batting tunnels
- > Tunnels share center supports spaced 5' apart for added safety
- > 4" OD aluminum tubing construction
- > Curved supports provide 3' offset
- > Clean design with less structure for ball to ricochet off
- > Ground sleeves (included) accommodate both 12' and 14' wide nets
- > Individual hoist lines make for easy installation and removal of net
- > Nets sold separately

PROTF-70T

70'L x 12'H

800 lbs

\$5,995 each

FR 3Y ★

PROTF-55T

55'L x 12'H

750 lbs

\$4,995 each

FR 3Y ★



Weighted Tunnel Sand Tubes

Ideal for keeping batting tunnel nets from blowing around.

- > 18 oz black vinyl tube with 5 clips to attach to the net
- > Add sand easily with 8" zippered opening
- > 14 tubes recommended for a 70'L x 12'W batting tunnel
- > Dimensions: 5"W x 60"L

SWB-TUBE

1 lb

\$29 each

3Y



www.jaypro.com
F: 800-988-3363

T: 800-243-0533



Semi-Permanent Outdoor Batting Tunnel Frame

- > 2" OD galvanized steel tube frame
- > Net hangs on 3 rows of 3/16" galvanized aircraft cable
- > Ground sleeves included
- > Accommodates both 12' and 14' wide nets
- > Net sold separately

BBTF-70	5 Wickets – 70'L x 12'H	
250 lbs	\$1,995 each	FR 3Y ★
BBTF-55	4 Wickets – 55'L x 12'H	
225 lbs	\$1,755 each	FR 3Y ★

Surface-Mounted Outdoor Batting Tunnel Frame

- > 2" OD galvanized steel tube frame has 6" square mounting plate for surface-mount installation
- > Net hangs on 3 rows of 3/16" galvanized aircraft cable
- > Accommodates both 12' and 14' wide nets
- > Net sold separately

BBTFSM-70	5 Wickets – 70'L x 12'H	FR 3Y ★
250 lbs	\$2,295 each	
BBTFSM-55	4 Wickets – 55'L x 12'H	
225 lbs	\$1,995 each	FR 3Y ★

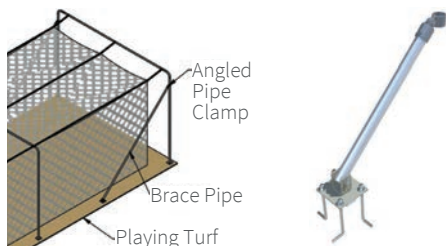

Batting Tunnel Frame Brace Kit

Secure all four corners by adding diagonal brace support to prevent end frames from bowing in due to cable tension.

- > Compatible with semi-permanent or surface-mount installations
- > Includes 4 braces, fittings and attachment hardware for 2" OD pipe
- > Note: Only for use with 1.9" OD frames

BBTF-BRKIT	150 lbs	\$635 kit	FR 3Y ★
-------------------	---------	-----------	-----------------------

All-Star Series Tunnel Nylon Net

- > #36 thread count and UV protected
- > Black twisted knotted nylon net with 1¾" sq mesh
- > 3/8" twisted poly rope borders

FR **1Y**

Item	Description	Weight	Price
BBC36-7014	14'W x 70'L x 12'H	134 lbs	\$1,739 each
BBC36-7012	12'W x 70'L x 12'H	123 lbs	\$1,689 each
BBC36-5514	14'W x 55'L x 12'H	107 lbs	\$1,489 each
BBC36-5512	12'W x 55'L x 12'H	100 lbs	\$1,439 each

Pro Climatized Tunnel Nets

- > Best for outdoor use
- > #42 thread count with twisted knot construction
- > 2.5mm polyethylene filament fiber with 1¾" sq mesh
- > High abrasion-resistant with roped perimeter and corners

FR **1Y**

Item	Description	Weight	Price
BBCP-7014	14'W x 70'L x 12'H	132 lbs	\$1,149 each
BBCP-7012	12'W x 70'L x 12'H	126 lbs	\$989 each
BBCP-5514	14'W x 55'L x 12'H	111 lbs	\$889 each
BBCP-5512	12'W x 55'L x 12'H	100 lbs	\$839 each

Major League UV Stabilized Tunnel Nets

- > #42 thread count and UV stabilized
- > Black knotless nylon net with 1¾" sq mesh

FR **1Y**

Item	Description	Weight	Price
BBC-470	14'W x 70'L x 12'H	106 lbs	\$1,339 each
BBC-370	12'W x 70'L x 12'H	102 lbs	\$1,289 each
BBC-270	14'W x 55'L x 12'H	86 lbs	\$1,089 each

Collegiate Climatized Tunnel Nets

- > Same features as our pro series but for youth
- > #24 thread count
- > 2mm polyethylene filament fiber with 1¾" sq mesh

FR **1Y**

Item	Description	Weight	Price
BBCC-7014	14'W x 70'L x 12'H	98 lbs	\$889 each
BBCC-7012	12'W x 70'L x 12'H	93 lbs	\$839 each
BBCC-5514	14'W x 55'L x 12'H	80 lbs	\$785 each
BBCC-3514	12'W x 55'L x 12'H	54 lbs	\$505 each



Batting Tunnel Accessories

Batting Tunnel Turf

Ideal for batting cage floors, dugouts, baselines, bullpens, coach boxes, walkways and more.

- > All turf is green and sold by the square foot
- > Excess turf may be trimmed in the field
- > Call for freight quote

34 oz Poly Turf

TURF34 \$2.29 sq ft **FR 1Y**
12'W Rolls - Unitary Backing

TURF34P \$4.09 sq ft **FR 1Y**
12'W Rolls - 5mm Padded Backing

30 oz Nylon Turf

TURF30 \$2.99 sq ft **FR 1Y**
12'W Rolls - Unitary Backing

TURF30P \$4.69 sq ft **FR 1Y**
12'W Rolls - 5mm Padded Backing

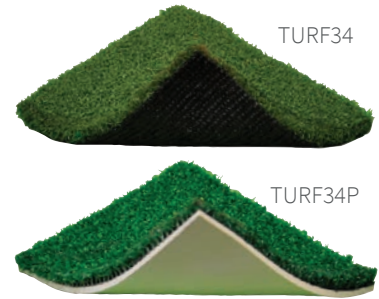

Batting Mat

- > Indoor/outdoor use
- > Spike-resistant artificial turf with throw down home plate
- > Inlaid white lines and thick foam backing
- > Dimensions: 12'W x 6'L

BML612G Green Clay 57 lbs \$375 each **1Y**
BML612CL Red Clay 57 lbs \$375 each **1Y**

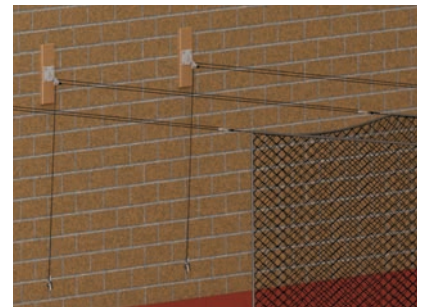

Quick Set-Up Indoor Batting Cage

A full-size batting cage that sets up in minutes without the need for a ladder.

- > Cage attaches wall to wall using three marine grade rigging blocks with locking cams to both tension and lock net in position
- > When not in use there are no cables or structure left behind to interfere with or obstruct other activities
- > Available in two sizes (other sizes available upon request)
- > Ships complete with all items needed for attaching to building structure
- > Wall Mounting Kit (BBC-WLKT) available if mounting to concrete or block walls
- > Optional Storage Cart (TENINJA-CART) sold separately

BBC-QS70 14'W x 70'L x 14'H
130 lbs \$3,450 each **FR 1Y**
BBC-QS55 14'W x 55'L x 14'H
130 lbs \$3,150 each **FR 1Y**
TENINJA-CART Storage Cart w/ Liner
50 lbs \$389 each **FR 3Y**

Cable Suspended Tunnel Kit

- > Maximize overhead space when net is in stored position
- > Allows support cables to be placed higher in the ceiling (up to 30')
- > Net suspended on 1/8" aircraft cable every 3' on center
- > Net and attachments sold separately

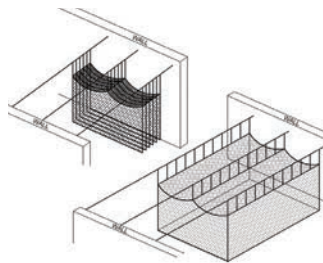

BBC-SPDKT \$1,650 each **3Y**

Cable Supported Tunnel Kit

- > (3) 100' rolls of 1/4" galvanized aircraft cable
- > Net attaches directly to cables running from wall to wall (attachment every 1')
- > Net slides easily against wall for storage
- > Ships complete with all necessary hardware
- > Net and attachments sold separately

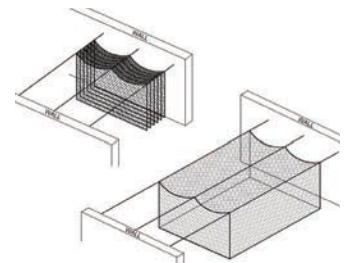

BBC-SPRTKT \$459 each **3Y**

Wall Mounting Kit

- > (6) finished wood pads and steel mounting plates
- > Attach to concrete, block or steel framed walls
- > Wall anchors to be supplied by installer based on wall specifications

BBC-WLKT \$1,125 each **3Y**



Indoor Batting Cages



Ceiling Suspended Retractable Batting Cage

- > 2" heavy-walled aluminum tube frame
- > Raise and lower from ceiling using a drive shaft powered by a 1 HP electric winch (key switch operated)
- > Net included
- > Ceiling mounting kit sold separately
- > Dimensions: 12'W x 70'L x 11'H
- > Note: 14' wide cages and custom sizes available (call for quote)

BBC-700B Baseball 675 lbs \$7,268 each

BBC-700M Multi-Sport 675 lbs \$9,742 each **FR** **3Y** **1Y** ★

Indoor Multi-Sport Tunnel Net

- > #252 UV stabilized knotless nylon net with 3/4" sq mesh
- > Dimensions: 12'W x 70'L x 12'H
- > Custom size available (call for pricing)

BBC-700N \$2,495 each **1Y**

See page 61 for Baseball Tunnel Net options.

Ceiling Mounting Kit - A

Direct Attached:
For cages centered directly beneath a beam or bar joist (system will be attached directly to single beam or bar joist).

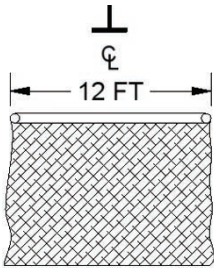

BBC-UBKIT \$489 each **3Y**

Ceiling Mounting Kit - B

> Spanning Parallel 8' on Center or Less:
For cages with a centerline located between two beams or bar joists spaced 8' apart or less.

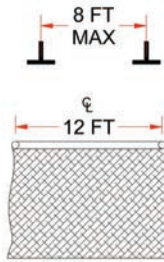

BBC-PARKITA \$909 each **3Y**

Ceiling Mounting Kit - C

> Spanning Parallel 8'-12' on Center: For cages with a centerline located between two beams or bar joists spaced greater than 8' but not over 12' apart.

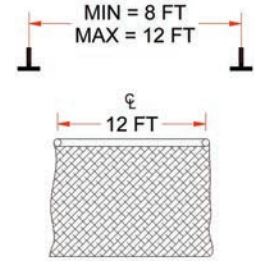

BBC-PARKITB \$2,325 each **3Y**

Ceiling Mounting Kit - D

> Spanning Perpendicular Not Greater Than 8' on Center: For cages oriented perpendicular to beams or bar joists spaced no greater than 8' apart.

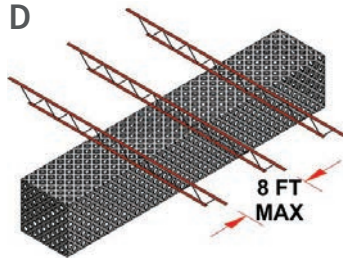

BBC-PERPKITA \$1,800 each **3Y**

Ceiling Mounting Kit - E

> Peaked or Rigid Frame Building (call for pricing)
> For cages being placed in a peaked rigid frame building
> Drive supports to be chained down from roof purlins with rigid winch support

BBC-RIGKIT Call for Pricing **3Y**

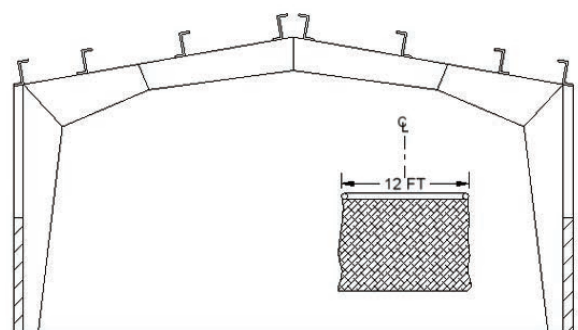

Ceiling Mounting Kit - F

> Spanning Perpendicular 8'-12' on Center: For cages oriented perpendicular to beams or bar joists spaced greater than 8' but not over 12' apart.

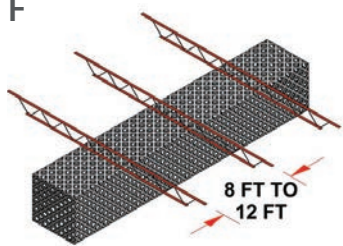

BBC-PERPKITB \$2,850 each **3Y**



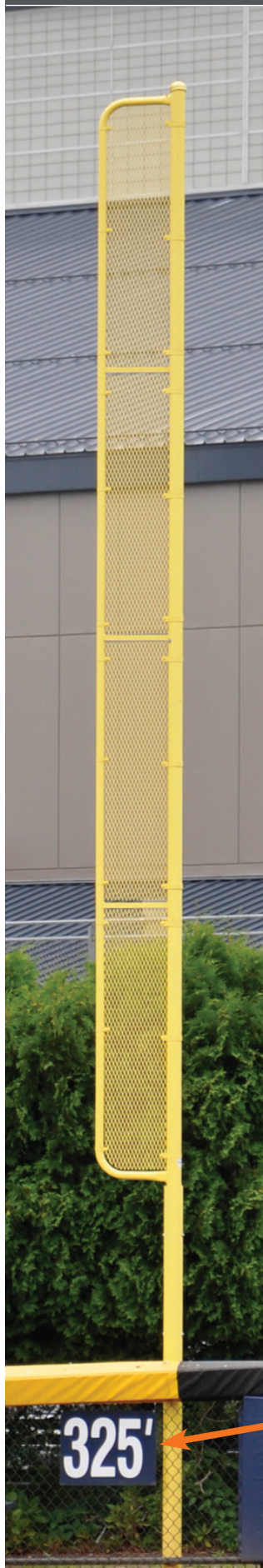

20' Professional Foul Pole

- > Designed to optimize air passage and engineered to withstand up to 120 mph winds
- > Main upright is 3½" OD Schedule 40 zinc coated steel tubing
- > 18"W x 12"H all-welded wing panel with heavy-duty 1½" x 13 gauge expanded metal mesh
- > Single piece welded steel construction designed for permanent, semi-permanent or surface-mount installation
- > Wall-mount installation available

See page 65 for optional ground sleeves for semi-permanent installation.

Baseball

FR ● 3Y ★

BBFP-20	YELLOW	Permanent/Semi-Permanent	570 lbs	\$2,395 pair
BBFP-20SM	YELLOW	Surface Mount	570 lbs	\$3,195 pair

Softball

FR ● 3Y ★

SBFP-200-WT	WHITE	Permanent/Semi-Permanent	570 lbs	\$2,495 pair
SBFP-200SM-WT	WHITE	Surface Mount	570 lbs	\$3,195 pair
SBFP-200-OR	ORANGE	Permanent/Semi-Permanent	570 lbs	\$2,495 pair
SBFP-200SM-OR	ORANGE	Surface Mount	570 lbs	\$3,195 pair

30' Professional Foul Pole

- > Designed to optimize air passage and engineered to withstand up to 120 mph winds
- > Main upright is 5" OD Schedule 40 zinc coated steel tubing
- > 18"W x 18"H all-welded 2" steel tube wing panel with heavy-duty 1½" x 13 gauge expanded metal mesh
- > 4" OD 8 gauge zinc coated upper pole
- > Two piece telescoping design for permanent, semi-permanent or surface-mount installation
- > Wall-mount installation available

See page 65 for optional ground sleeves for semi-permanent installation.

Baseball

FR ● 3Y ★

BBFP-30	YELLOW	Permanent/Semi-Permanent	850 lbs	\$3,995 pair
BBFP-30SM	YELLOW	Surface Mount	850 lbs	\$4,995 pair

Softball

FR ● 3Y ★

SBFP-30-WT	WHITE	Permanent/Semi-Permanent	850 lbs	\$4,095 pair
SBFP-30SM-WT	WHITE	Surface Mount	850 lbs	\$4,495 pair
SBFP-30-OR	ORANGE	Permanent/Semi-Permanent	850 lbs	\$4,095 pair
SBFP-30SM-OR	ORANGE	Surface Mount	850 lbs	\$4,495 pair

Over 30' Professional Foul Pole

- > Permanent, semi-permanent or surface-mount options available
- > Wall-mount installation available

Call customer service for details.

FR ● 3Y ★

Outfield Distance Markers

- > Printed digitally on 13 oz reinforced vinyl fabric
- > Specify colors and numbers when ordering
- > Marker Colors: Forest Green, Red, Yellow, Royal Blue, Gray, Tan and Black
- > Number Colors: White, Yellow, Black and Blue

ODM-23	27" x 36" Marker w/ 14" Numbers	\$129 each	1Y
ODM-35	38" x 56" Marker w/ 24" Numbers	\$139 each	1Y

FOREST GREEN
RED
YELLOW
ROYAL BLUE
GRAY
TAN
BLACK

325'





20' Collegiate Foul Pole

- > Main upright is 3½" OD steel tubing
- > 18"W x 12'H bolt-on wing panel is all steel expanded metal
- > 20' tall when installed
- > Powder coated finish over zinc undercoating
- > Designed for permanent or semi-permanent (with optional sleeve) installation
- > Wall-mount installation available



Baseball

BBCFP-20

YELLOW

300 lbs

Permanent/Semi-Permanent

\$1,449 pair

FR 3Y

Softball

SBCFP-200-WT

WHITE

300 lbs

Permanent/Semi-Permanent

\$1,449 pair

FR 3Y

SBCFP-200-OR

ORANGE

300 lbs

Permanent/Semi-Permanent

\$1,449 pair

30' Collegiate Foul Pole

- > Main upright is 4½" OD heavy-walled steel tubing with 4" OD upper pole
- > 18"W x 18'H bolt-on wing panel is all steel expanded metal
- > 30' tall when installed
- > Powder coated finish over zinc undercoating
- > Two piece telescoping design for permanent or semi-permanent (with optional sleeve) installation
- > Wall-mount installation available

Baseball

BBCFP-30

YELLOW

650 lbs

Permanent/Semi-Permanent

\$2,495 pair

FR 3Y

Softball

SBCFP-30-WT

WHITE

650 lbs

Permanent/Semi-Permanent

\$2,595 pair

FR 3Y

SBCFP-30-OR

ORANGE

650 lbs

Permanent/Semi-Permanent

\$2,595 pair

12' Baseball/Softball Foul Pole

- > Main upright is 3½" OD heavy-duty steel tubing
- > 18"W x 6'H bolt-on wing panel is all steel expanded metal
- > 12' tall when installed
- > Powder coated finish over zinc undercoating
- > Designed for permanent or semi-permanent (with optional sleeve) installation
- > Wall-mount installation available

Baseball

BBSBFP-12

YELLOW

200 lbs

Permanent/Semi-Permanent

\$999 pair

FR 3Y

Softball

SBCFP-12-WT

WHITE

200 lbs

Permanent/Semi-Permanent

\$999 pair

FR 3Y

SBCFP-12-OR

ORANGE

200 lbs

Permanent/Semi-Permanent

\$999 pair



Foul Pole Ground Sleeves

- > For semi-permanent installation of foul poles
- > Facilitates installation and maintenance

3Y

FPS-12	12' Sleeves	18 lb	\$225 pair
FPS-20	20' Sleeves	24 lbs	\$269 pair
FPS-30C	30' Sleeves (for BBCFP-30 only)	36 lbs	\$299 pair
FPS-30P	30' Sleeves (for BBFP-30 only)	40 lbs	\$459 pair

Big League Screens

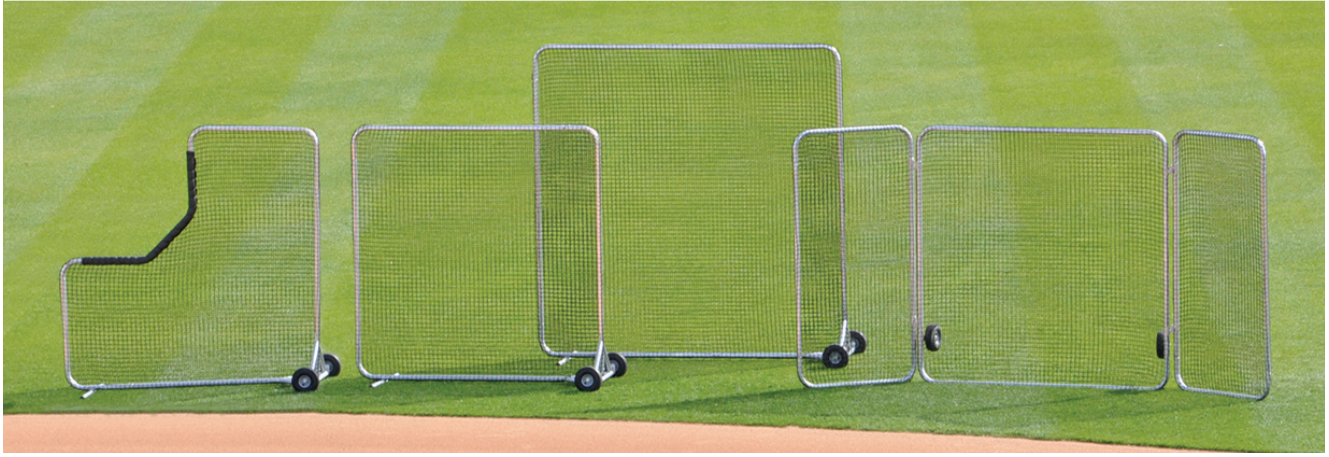

Big League Pitchers Screen

- > Larger size for the pro player
- > 2" OD heavy-walled Schedule 40 aluminum L-shaped construction
- > 2" heavy-duty legs and supports welded for extra strength
- > #42 knotless weatherproof double-sided slip-on nylon net
- > (2) 10" dia x 4" wide no-flat tires
- > Padded hip protector included for pitcher safety
- > Dimensions: 8'W x 8'H

See page 35 for optional sandbags to counterweight screen.

BLPS-84	Screen	
45 lbs	\$769 each	
BLPS-84N	Replacement Net	
3 lbs	\$219 each	
		3Y 1Y ★



Big League Fungo Screen

- > Larger size to protect fielders from stray balls
- > 2" OD heavy-walled Schedule 40 aluminum construction
- > 2" heavy-duty legs and supports welded for extra strength
- > #42 knotless weatherproof double-sided slip-on nylon net
- > (2) 10" dia x 4" wide no-flat tires
- > Available in 2 sizes

See page 35 for optional sandbags to counterweight screen.

BLFS-88	8' x 8' Screen	
45 lbs	\$789 each	
BLFS-101	10' x 10' Screen	
55 lbs	\$869 each	
BLFS-88N	8' x 8' Replacement Net	
3 lbs	\$205 each	
BLFS-101N	10' x 10' Replacement Net	
4 lbs	\$245 each	
		FR 3Y 1Y ★



Big League Fungo Screen with Wings

- > Larger size for 2nd base or infield protection
- > Wings fold in for easy transport
- > 2" OD heavy-walled Schedule 40 aluminum construction
- > #42 knotless weatherproof double-sided slip-on nylon net
- > (2) 10" dia x 4" wide no-flat tires
- > Center Screen: 8'W x 8'H
- > Wing Screens: 4'W x 8'H
- > Dimensions: 16'W x 8'H

See page 35 for optional sandbags to counterweight screen.

BLFSW	Screen	
90 lbs	\$1,029 each	
BLFSW-N	Wing Replacement Net	
3 lbs	\$115 each	
BLFS-88N	Center Replacement Net	
3 lbs	\$205 each	
		3Y 1Y ★

Safefoam Padding

Provide another layer of safety to pitcher and fielder screens.

- > Ships in 8' lengths
- > Available in 3 colors
- > Colored ties to attach padding sold separately

SF-PREMRB	ROYAL BLUE	Padding	\$59 each
SF-PREMRD	RED	Padding	\$59 each
SF-PREMGR	GREEN	Padding	\$59 each
SF-TIESRB	ROYAL BLUE	19" Ties (Bag of 100)	\$42 bag
SF-TIESRD	RED	19" Ties (Bag of 100)	\$42 bag
SF-TIESGR	GREEN	19" Ties (Bag of 100)	\$42 bag

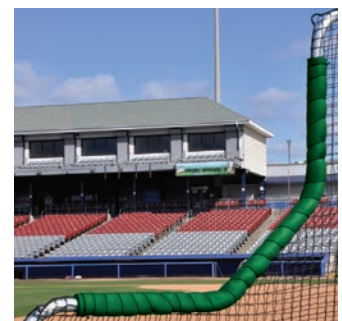

1Y





Collegiate Pitchers Screen

- > Required protection screens for players during batting and fielding practice
- > Works with pitching machines or live arm delivery
- > 1½" OD heavy gauge galvanized steel L-shaped construction
- > 2" heavy-duty square galvanized steel legs
- > #36 knotless weatherproof double-sided slip-on nylon net
- > (2) 8" dia wheels

PS-84	7' x 7' Screen	67 lbs	\$299 each
PS-84N	7' x 7' Replacement Net	3 lbs	\$109 each
PSE-76N	7' x 6' Green Economy Net	3 lbs	\$82 each



Collegiate Fielders Screen

- > Required protection screens for players during batting and fielding practice
- > 1½" OD heavy gauge galvanized steel construction
- > 2" heavy-duty square galvanized steel legs
- > #36 knotless weatherproof double-sided slip-on nylon net
- > (2) 8" dia wheels
- > Available in 2 sizes

FS-77	7' x 7' Screen	67 lbs	\$299 each
FS-101	10' x 10' screen	77 lbs	\$349 each
FS-77N	7' x 7' Replacement Net	3 lbs	\$119 each
FS-101N	10' x 10' Replacement Net	4 lbs	\$149 each
FSE-76N	7' x 6' Green Economy Net	3 lbs	\$79 each



Softball Protector Screen

- > Ideal for softball pitchers
- > 7'W x 7'H frame with cutout
- > Net and wheel kit included

SBPE-77	7' x 7' Screen	67 lbs	\$299 each		
SBPE-77N	7' x 7' Replacement Net	3 lbs	\$109 each		



Portable Soft Toss/Batting Practice Screen

- > Heavy duty frame for use with baseball/softball
- > Balls collected in sock for reuse
- > Pillowcase style net and wheel kit included

PSTS-77	7' x 7' Screen	67 lbs	\$349 each		
PSTS-77N	7' x 7' Replacement Net	3 lbs	\$149 each		
PSTS-76N	7' x 6' Green Economy Net	3 lbs	\$82 each		



Short Sided Pitchers Screen

Ideal for use in batting tunnels or indoors.

- > Narrow width screen
- > 1½" OD heavy gauge galvanized steel L-shaped construction
- > 2" heavy-duty square galvanized steel legs
- > #36 knotless weatherproof double-sided slip-on nylon net
- > (2) 8" dia wheels
- > Dimensions: 7' x 5'

PS-75	Screen	65 lbs	\$497 each		
PS-75N	Replacement Net	3 lbs	\$159 each		



Bases



Flex Style Bases

- Ideal for recreational or competition level of play.
- > 3 impact bases are shock absorbing and compress on impact
 - > 3 anchors and (3) 1½" solid rubber plugs included
 - > Base Dimensions: 15" x 15" x 3"

BB-200 33 lbs \$199 set **3Y**



Pro-Style Hollywood Bases



- Used by the pros and ideal for advanced levels of play.
- > 3 bases with a tapered lip that digs into the dirt (bases do not compress)
 - > 3 anchors and (3) 1½" solid rubber plugs included
 - > Base Dimensions: 15" x 15" x 3"

BB-500 39 lbs \$199 set **3Y**



Breakaway Style Bases

Fully compliant with Little League® Rule 1.06

- > 3 quick release bases disengage from stationary rubber base plate upon impact
- > 3 anchors and (3) 1½" solid rubber plugs included
- > Base Dimensions: 15" x 15" x 3"

BB-700 39 lbs \$299 set **3Y**



Bolco Style Bases

- > 3 bases are heavy-duty injected vinyl cover with a bonded polyester foam core
- > (3) 1" anchors and bolt-on plates included
- > Base Dimensions: 15" x 15" x 3"

BB-600 28 lbs \$215 set **3Y**

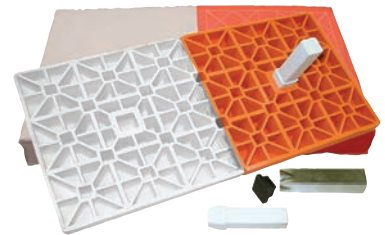

Double First Base

- > Double first base reduces collisions and compresses on impact
- > 2 anchors and (2) 1½" solid rubber plugs included
- > Base Dimensions: 30" x 15" x 3"

BB-400 26 lbs \$149 each **3Y**



Recreation Double First Base

- > Foam-filled with nylon quilted cover
- > Straps and 3 spikes included
- > Base Dimensions: 30" x 15" x 3"

BB-150 5 lbs \$49 each **3Y**



Official Size Economy Bases

- > 3 foam-filled bases with heavy-duty quilted covers
- > 2 nylon straps and 4 steel anchors included
- > Base Dimensions: 15" x 15" x 3"

BB-100 10 lbs \$56 set **3Y**



Home Plate Extension

- > Provides an extended strike zone
- > More visible for umpires to make calls
- > White molded vinyl composition

HPEXT 2 lbs \$20 each **3Y**



Rubber Throw Down Home Plate & Bases

- > Heavy-duty molded rubber with waffle bottom
- > Bases are 13½" square and 1/2" thick

HP-300 Home Plate 7 lbs \$18 each **3Y**

BB-350 Bases (Set of 3) 9 lbs \$38 set **3Y**



Throw Down Bases

- > Flexible and washable rubber bases for indoor/outdoor use
- > 3 bases, home plate and pitching rubber included

BB-50 5 lbs \$16 set **3Y**



www.jaypro.com
T: 800-243-0533 F: 800-988-3363

T: 800-243-0533

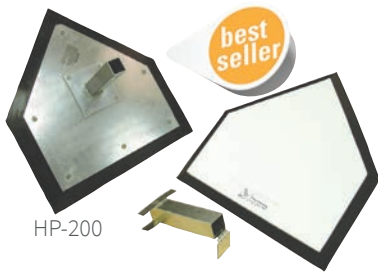

HP-200



HP-250

Major League Home Plate

- > Durable molded rubber construction
- > Stanchion-mounted steel plate
- > Easily removed for maintenance or storage

HP-200 Plate w/ 1/2" Anchor
16 lbs \$99 each 3Y

HP-250 Plate w/ 5 Zinc-Plated Spikes
16 lbs \$129 each 3Y



Professional Pitching Rubber

- > Major League Size: 6" x 24"
- > Durable four-sided molded rubber exterior
- > Interior PVC tube provides maximum longevity
- > Fill with dirt or concrete for added stability

PR-624 20 lbs \$99 each 3Y

Professional Pitching Rubber

- > Little League Size: 18" long
- > Same features as the (PR-624)

PR-618 10 lbs \$79 each 3Y

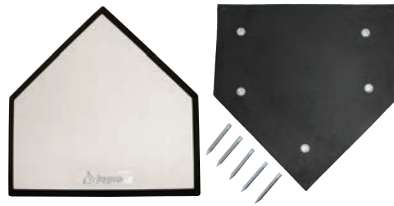

Economy Home Plate

- > Durable molded rubber construction
- > 5 removable spikes included

HP-50 10 lbs \$33 each 3Y

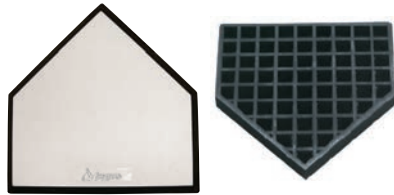

Bury-All Home Plate

- > Durable all rubber construction
- > No-skid rubber waterproof surface
- > No corners or edges to catch spikes

HP-100 24 lbs \$89 each 3Y



Bury-All Home Plate

- > Durable wood-filled construction
- > No-skid rubber waterproof surface
- > No corners or edges to catch spikes

HP-150 29 lbs \$99 each 3Y

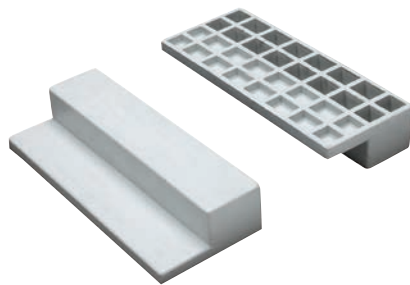

Step Down Pitching Rubber

- > Official Size: 24" long
- > Heavy-duty all rubber construction or wood-filled
- > Step down style for better footing
- > Reduces pitcher's mound maintenance

PR-524 19 lbs \$82 each 3Y

Step Down Pitching Rubber

- > Little League Size: 18" long
- > Same features as the (PR-524)

PR-518 10 lbs \$69 each 3Y

Step Down Pitching Rubber

- > Official Size: 24" long
- > Heavy-duty wood-filled construction
- > Step down style for better footing
- > Reduces pitcher's mound maintenance

PR-550 19 lbs \$92 each 3Y



Removable Pitching Rubber

Ideal for diamonds where various levels of play may require different pitching distances.

- > Heavy molded rubber
- > Steel ground anchors included

PR-424 Official (24" long)
14 lbs \$75 each 3Y

PR-418 Youth (18" long)
10 lbs \$65 each 3Y

Movable Pitching Rubber

Ideal for diamonds where various levels of play may require different pitching distances.

- > Heavy molded rubber
- > 3 removable metal spikes included

PR-324 Official (24" long)
10 lbs \$20 each 3Y

PR-318 Youth (18" long)
10 lbs \$17 each 3Y



Base Accessories



StackMaster™ Professional Base Package

- > Pro-Style Hollywood Bases (BB-500)
- > StackMaster™ Professional Base Cart (BBBCART)

BCARTSET 72 lbs \$349 package

3Y

STACKMASTER™
Professional Base Cart



- > Transports and stores heavy pro bases and male/female receptacles
- > Heavy-duty square steel frame
- > Pneumatic tires for easy transport
- > Note: Cannot be used with "Flex" Style Bases (BB-200) or Double First Bases (BB-400)

BBBCART 33 lbs
\$229 each **3Y**

Soft Touch Bases

Ideal for synthetic turf fields with a depth of 1" and held in place with polyurethane spikes (can remain in ground year round or easy game time installation).

- > Significant pressure required to release bases
- > Base Dimensions: 15' x 15' x 2½"
- > Call for freight quote

BB-3TF	3 Bases (White)	56 lbs	\$599 set	1Y
BB-1TF	1 Base (White)	20 lbs	\$249 each	1Y
BB-1TFOR	1 Base (Orange)	20 lbs	\$249 each	1Y
BB-THP	1 Home Plate	4 lbs	\$229 each	1Y
BB-TPR	1 Pitching Rubber	6 lbs	\$229 each	1Y



Cleat Cleaner

Ideal for use at pitcher's mound, on-deck circle or dugout areas.

- > Polyurethane composition with molded handle
- > 4 steel spikes included
- > 8 rows of 13 spikes (14" x 19½")

CLTCLN 4 lbs
\$40 each **3Y**



Pre-Assembled Anchor Foundation

The fastest and easiest way to install base anchors.

- > Pre-assembled recycled rubber base foundation is ready to install
- > Fits 1½" anchors and includes female anchor
- > Base(s) sold separately
- > Call for freight quote

For Hollywood, Magnetic, Bolco Style Bases

PABF1	Single	3 lbs	\$59 each	1Y
PABF3	Set of 3	9 lbs	\$155 set	1Y

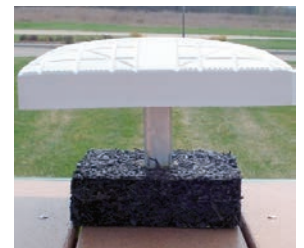

Base Dig-Out Tool

BB-DIGOUT 1 lb
\$11 each **3Y**

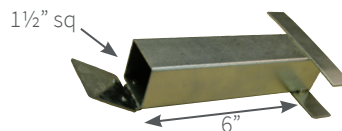
Base Rubber Plug

BB-PLUG 1 lb
\$7 each **3Y**



Big League Base Plug

BB-BLBP 1 lb
\$12 each **3Y**

- > For both 1½" and 1¾" sleeves
- > Order 3 for a complete set



Base Anchors

BB-ANCHOR 1 lbs \$9 each **3Y**

Anchor Plug

BB-RAP 1 lb
\$7 each **3Y**



1¾" Base Anchors (Set of 3)

BB-ANCHOR175
3 lbs \$36 set **3Y**

1½" Base Anchor

BB-ANCHOR150
1 lb \$11 each **3Y**





Baseball Cart

- > Large capacity basket holds hundreds of baseball/softballs
- > 1½" OD heavy-duty steel frame is powder coated
- > 14" oversized no-flat tires
- > Dimensions: 17"W x 16"H x 24"D

BCT-100 \$215 each
35 lbs  **3Y**



Super Batting Tee

Ideal for all ages and abilities.

- > Heavy-weighted rubber base with steel insert for added weight
- > Telescoping height is 22" to 37" (approx.)
- > Baseball not included

BT-1 12 lbs \$29 each  **3Y**



Game Mounds

Instantly convert a softball field to a youth baseball field.

- > Official Little League height specifications
- > Indoor/outdoor use
- > High-density foam and protected for durability
- > Use with turf shoes only (no metal cleats)
- > Call for freight quote

Major League Game Mound

PPM-660G Green - 60"W x 99"L x 6"H
70 lbs \$1,149 each  **1Y**

PPM-660CL Red Clay - 60"W x 99"L x 6"H
70 lbs \$1,149 each  **1Y**

Youth Game Mound

PPM-652G Green - 52"W x 45"L x 6"H
36 lbs \$549 each  **1Y**

PPM-652CL Red Clay - 52"W x 45"L x 6"H
36 lbs \$549 each  **1Y**



Carry Bag

- > Store and transport 64 baseballs or 36 softballs
- > Zipper top and carry straps included
- > Dimensions: 12"W x 14"H x 12"D

RBF-BASE \$30 each  **3Y**
3 lbs



Deluxe Batting Tee

- > Durable official size rubber home plate
- > Telescoping height is 22" to 37" (approx.)
- > Baseball not included

BT-4 11 lbs \$39 each  **3Y**

Cage Saver Target



- > Heavy-duty 40 oz reinforced black vinyl tarp with white strike zone
- > Brass grommets along edges
- > 2 straps with clips to hang included
- > Call for freight quote
- > Dimensions: 5"W x 6"H

CST65 11 lbs
\$139 each  **1Y**



Permanent Bat Rack

- > Heavy-duty galvanized steel bat rack holds up to 14 bats
- > Permanently mounts to dugout surface

PBR-14 33 lbs \$165 each  **3Y**



Hanging Bat Rack Attachment

- > Heavy-duty galvanized steel bat rack holds up to 14 bats
- > Attaches to dugout fence or wall with included hardware

PBR-14WM 5 lbs
\$115 each  **3Y**

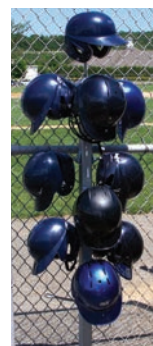

StackMaster™ Batting Helmet Storage Rack

- > Galvanized steel frame stores up to 12 helmets
- > Anchor to ground is recommended for secure installation

BHR-1 28 lbs
\$199 each  **3Y**



www.jaypro.com
T: 800-243-0533 F: 800-988-3363

Field Covers & Wind Screens

Field Covers • Rolling Tubes Fitted Sideline Covers

Assorted sizes available
Call customer service for details



Weighted Spot Covers

- > 6 oz polyethylene silver/white cover with weighted hem
- > Stakes or sandbags not required
- > Call for freight quote

1Y ★

Item	Description	Price
WWMC18	Mound Cover 18' round	\$619 each
WWMC20	Mound Cover 20' round	\$719 each
WWMC26	Mound Cover 26' round	\$919 each

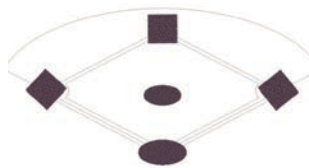

SILVER WHITE



Spot Covers

- > Lightweight and durable rip-resistant 6 oz woven polyethylene covers
- > Heat sealed to ensure waterproof protection
- > Grommets spaced at 3'-4' intervals
- > Stakes included
- > Call for freight quote

1Y ★

Item	Description	Dimensions	Price
AFC-PM	Pitcher's Mound (7 stakes)	20' Round	\$259 each
AFC-HP	Home Plate (9 stakes)	26' Round	\$365 each
AFC-BC3	Bases - Set (15 stakes)	10' x 10' set of 3	\$239 each

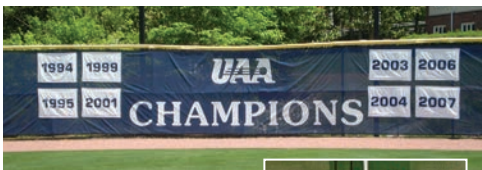

Armor Mesh Wind Screen



- > Provides 75% shade and available in two heights
- > 14 oz woven extrusion vinyl coated polyester mesh
- > IncrediSeal™ heat sealed hem provides a clean look and eliminates risk of stitches/seams coming undone
- > Wind vents and cable ties sold separately
- > See chart for colors (specify when ordering)
- > Call for freight quote

WSCRN-6	6' Height	\$0.89 sq ft	FR	5Y
WSCRN-9	9' Height	\$0.99 sq ft	FR	5Y

TuffPrint Lettering and Logos

WSCRNLG Call for Details and Pricing



Classic Wind Screen

- > Provides 84% shade and available in two heights
- > 8.2 oz/sq yd PVC coated polyester open mesh
- > Reinforced hems and rust-resistant grommets spaced at 18" intervals
- > 18" dia half-moon wind vents (HMV-18) recommended to allow wind passage (sold separately)
- > Plastic cable ties (PCT-100) for installation sold separately
- > Windscreen customization available
- > See chart for colors (specify when ordering)
- > Call for freight quote

FR 3Y

Item	Description	Price
TWS-6	6' High Screen	\$.71 sq ft
TWS-9	9' High Screen	\$.73 sq ft
PCT-100	Plastic Cable Ties	\$12 set of 100
HMV-18	Half Moon Wind Flap	\$4.99 each

Maximum length of a single piece wind screen is 100'. Screens over 100' will be made in sections. Custom heights above 6' will be charged at 9' pricing. Heights cannot exceed 9'. Wind screens higher than 6' require a centered horizontal lacing lip along entire length.

FOREST GREEN	BLACK	NAVY BLUE	MAROON	BROWN	PURPLE	WHITE	YELLOW
ROYAL BLUE	RED	ORANGE	CAROLINA BLUE	TAN	KELLY GREEN	GRAY	



www.jaypro.com
T: 800-243-0533 F: 800-988-3363

T: 800-243-0533

Temporary Fencing Available One-Piece Kits for Baseball & Softball

Call customer service for details



Fence Top Protection

Ideal for reducing player injuries and increase visibility of fence.

- > 4" dia yellow corrugated plastic pre-slit for top fence rail installation
- > Secure with tie wraps every 2' (sold separately)
- > Call for freight quote

FR 1Y



Item	Description	Price
CFC-100YW	100' Coil Fence Crown	\$179 each
CFC-250YW	250' Coil Fence Crown	\$259 each
CFC-TIESYW	19" Ties (Bag of 100)	\$47 bag
CFC-ITOOL	Installation Tool	\$76 each



Safety Top Cap

Ideal for reducing player injuries and increase visibility of fence.

- > Snaps over fence top and locks to wire mesh with steel hog rings
- > HDPE plastic composition with UV stabilizers
- > Set of (5) 8' long sections and 15 hog rings
- > Call for freight quote

STC-8 \$115 set 1Y



Safeoam Tubular Padding

Ideal for railings and tubing. Even better for pitchers and fielders screens.

- > Tubular thick foam padding with durable skin coating
- > Fits any 2 1/8" diameter or less round pipe
- > 8' long sections pre-slit for installation
- > Minimum order of 6 pieces
- > Secure with tie wraps every 2' (sold separately)
- > Available in 4 colors
- > Call for freight quote

1Y

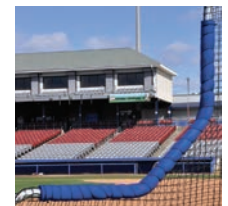

Item	YELLOW	ROYAL BLUE	RED	GREEN	Price
Padding	SF-PREMYW	SF-PREMRB	SF-PREMRD	SF-PREMGR	\$59 each
100 Ties	SF-TIESYW	SF-TIESRB	SF-TIESRD	SF-TIESGR	\$42 bag

Deluxe FenceTop & Rail Padding

Ideal for padding dug-out railings and fence tops.

- > 2" thick foam in 6' long sections encased in 18 oz vinyl
- > Grommets every 6" for attachment
- > See chart for vinyl colors (specify when ordering)
- > Call for freight quote

PRAFTP6 \$99 per 6' Section 1Y



ROYAL BLUE	GRAY
FOREST GREEN	WHITE
RED	BLACK



Field Maintenance

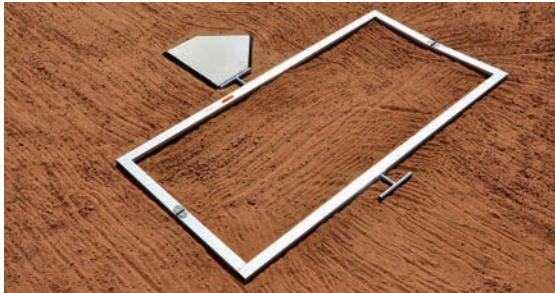

Batter's Box Template

- > Lightweight aluminum frame template imprints 2" pattern for chalking
- > Carry handle aligns with home plate for proper positioning
- > Available in official, little league and softball sizes
- > Folds for easy transport and storage

BBTMOFF	Official - 4' x 6'	29 lbs	\$289 each	3Y
BBTMLL	Little League - 3' x 6'	28 lbs	\$269 each	3Y
BBTMSB	Softball - 3' x 7'	29 lbs	\$269 each	3Y

See page 77 for our smaller field markers (FLMR-10) and (FLMR-25) to mark out your Batter's Box Template.

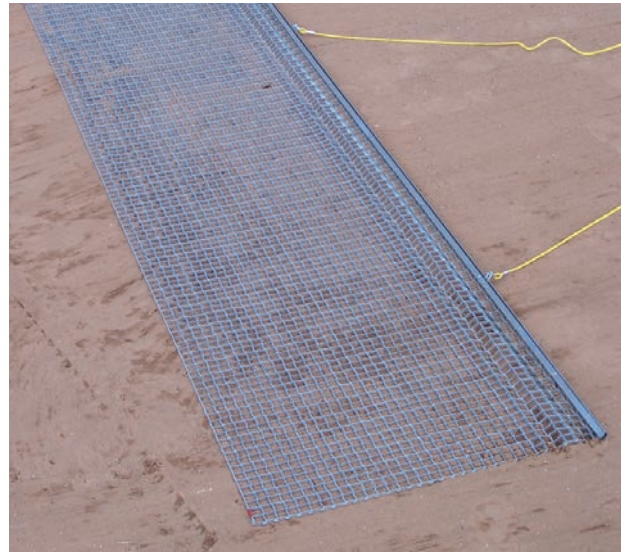

Infield Drag Mat



- > Flexible plated steel mesh mat with 1⁹/₁₆" galvanized steel drag bar
- > 3/8" polypropylene rope handle
- > Available in 3', 5' and 6' widths

DM-34	3'W x 4'D	21 lbs	\$139 each	3Y
DM-5	5'W x 3'D	27 lbs	\$159 each	3Y
DM-63	6'W x 3'D	33 lbs	\$229 each	3Y
DM-6	6'W x 6'D	65 lbs	\$339 each	3Y



Dirt Tamp

- > Durable all steel construction
- > 12" double-dipped vinyl grip handle included
- > Available in two sizes

DT-88	8" x 8"	12 lbs	\$85 each	1Y
DT-1010	10" x 10"	15 lbs	\$90 each	1Y

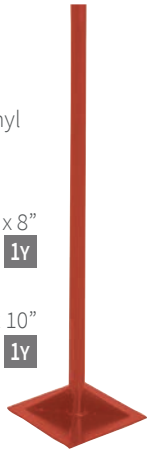

Loop Hoe

- > 60" powder coated aluminum handle with 6" non-slip vinyl grip

LH-60	2 lbs	\$41 each	1Y
--------------	-------	-----------	-----------



Sifting Shovel

- Ideal for spreading top dressing.
- > Perforated scoop sifts debris from all types of soil
 - > 42" long handle with 14" x 17" scoop

SS42	5 lbs	\$109 each	1Y
-------------	-------	------------	-----------

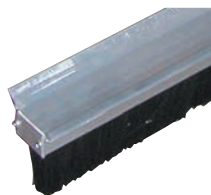

Monster Drag Broom

- > Heavy-duty aluminum construction with foam covered handle
- > 7' head with 2 rows of removable bristles

MDB-84	13 lbs	\$240 each	1Y
---------------	--------	------------	-----------



Double Play Monster Drag Broom

- > Heavy-duty aluminum construction with foam covered handle
- > 7' head with scarifying edge and 2 rows of removable bristles

DPMDB-84	17 lbs	\$279 each	1Y
-----------------	--------	------------	-----------



Double Play Scarifier Broom

- > Aluminum powder coated blue handle
- > 28" head with scarifying edge and two rows of removable bristles

DPSB-28 8 lbs \$145 each **1Y**



Base Runner Rake

- > Lightweight aluminum/magnesium alloy head construction
- > Double locking telescopic fiberglass handle adjusts from 30" to 70"
- > 36" grading edge with cleaning teeth
- > Breaks down for convenient storage

BRR-36 5 lbs \$105 each **1Y**

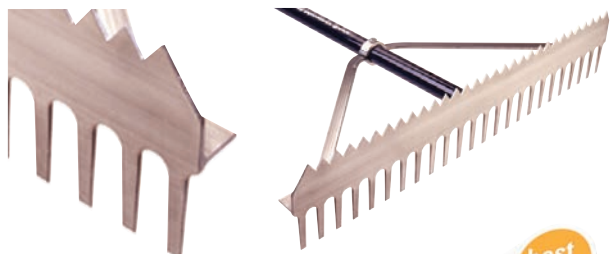

Double Play Rake

- > High-grade aluminum head and bracing
- > 66" powder coated aluminum handle with 5" no-slip vinyl grip
- > Available in two head sizes

DPR-24 24" Rake 6 lbs \$85 each **1Y**

DPR-36 36" Rake 6 lbs \$90 each **1Y**

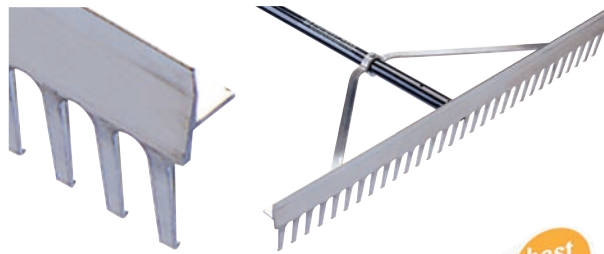

Field Rake

- > 66" lightweight aluminum/magnesium alloy head construction
- > Large 36" or 42" grading edge with heavy-duty cleaning teeth

FR-36 36" Rake 6 lbs \$74 each **1Y**

FR-42 42" Rake 6 lbs \$84 each **1Y**

Water Hoses & Nozzles



GH Series Irrigation Hose

GHXXX
\$249 each



Ultralite High Pressure Irrigation Hose

UPHXXX
\$319 each



Multi Mist Nozzle

MNZ-1
\$109 each



Garden Hose Thread Nozzle

GNZ-1
\$92 each



Dual Size Shower Head Nozzle

DSNZ-2
\$29 each



Adjustable Fan Stream Nozzle

AFNZ-1
\$99 each



Jaypro Sports offers a wide variety of irrigation products to address all field care needs.

Visit www.jaypro.com for a complete list of water hoses and nozzles.



www.jaypro.com
T: 800-243-0533 F: 800-988-3363

Basic Field Marking Package

- > 50 lb EasyLiner™ Field Marker (FLMR-50HD)
- > Base Runner Rake (BRR-36)
- > Base Dig-Out Tool (BB-DIGOUT)
- > ProLine Layout & Marking System (FM-LM1)
- > Official Batter's Box Template (BBTMOFF)



FMP-1OFF 85 lbs

\$699 package



Same products as FMP-1OFF except with:

- > Softball Batter's Box Template (BBTMSB)

FMP-1SB 85 lbs

\$689 package



Same products as FMP-1OFF except with:

- > Little League Batter's Box Template (BBTMLL)

FMP-1LL 84 lbs

\$689 package



Deluxe Field Marking Package

- > Includes all items in Basic Package
- > Infield Drag Mat (DM-5)
- > 10 lb EasyLiner™ Field Marker (FLMR-10)
- > EasyLiner™ Aerosol Spray Kit (FLMR-AKIT)



FMPD-2OFF 144 lbs

\$989 package



Same products as FMPD-2OFF except with:

- > Softball Batter's Box Template (BBTMSB)

FMPD-2SB 144 lbs

\$975 package



Same products as FMPD-2OFF except with:

- > Little League Batter's Box Template (BBTMLL)

FMPD-2LL 143 lbs

\$975 package



EasyLiner™ a jaypro sports product



100 lb EasyLiner™ Field Marker

- > 100 lb capacity
- > 2" or 4" line precision control
- > Heavy-duty 18 gauge steel hopper and frame
- > Line dispenser viewing window
- > (4) 10" no-flat wheels
- > Dual wheel drive for no-slip feed consistency
- > Instant on/off gate control
- > Adjustable fold in handles for off-season storage
- > Side mounted storage box
- > Dry line to spray capable with optional aerosol spray kit (FLMR-AKIT)

FLMR-100HD 70 lbs \$370 each   



50 lb EasyLiner™ Field Marker

- > 50 lb capacity
- > 2" or 4" line precision control
- > Heavy-duty 18 gauge steel hopper and frame
- > Line dispenser viewing window
- > (4) 10" no-flat wheels
- > Dual wheel drive for no-slip feed consistency
- > Instant on/off gate control
- > Adjustable fold in handles for off-season storage
- > Side mounted storage box
- > Dry line to spray capable with optional aerosol spray kit (FLMR-AKIT)





FLMR-50HD 62 lbs \$340 each   



25 lb EasyLiner™ Field Marker

- > 25 lb capacity
- > 2" or 4" line precision control
- > Heavy-duty 18 gauge steel hopper and frame
- > (2) 8" wheels
- > Dual wheel drive for no-slip feed consistency
- > Instant on/off gate control

FLMR-25 28 lbs \$170 each  



10 lb EasyLiner™ Field Marker

Ideal for touch-ups and small applications.

- > 10 lb capacity
- > 2" wide line
- > Heavy-duty 18 gauge steel hopper and frame
- > 2 wheels
- > 200 yard capacity

FLMR-10 13 lbs \$95 each  

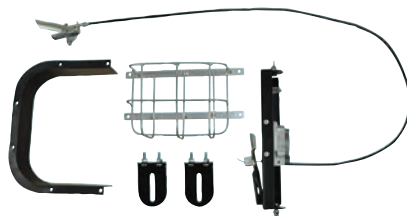

EasyLiner™ Aerosol Spray Kit

Add aerosol spray capability to your dry line marker.

- > Easy setup
- > 100/50 lb EasyLiner™ Field Marker compatible
- > Side mount aerosol can basket included
- > Applicator assembly, mounting brackets, air deflector included

FLMR-AKIT 3 lbs \$79 kit 



www.jaypro.com
T: 800-243-0533

F: 800-988-3363

Wet Line Field Markers



Battery Powered High Pressure Field Marker



SupaTurf TXE Standard Line Marker

Recognized as the industry standard and ideal for venues with multiple fields.

- > Robust, lightweight, easy to operate
- > 1" to 5" line width capable
- > Battery powered/No engine noise or pollution
- > Handlebar controls
- > High pressure spray nozzle
- > Mark multiple fields with a single tank
- > Fold over handle for off-season storage
- > Easy to clean and maintain
- > FREE marking disks included
- > Accessories available at www.jaypro.com

FM-TXE353 7 amp (minimum 2 hours per charge)
67 lbs \$1,499 each **3Y** **X**

FM-TXE606 18 amp (minimum 5 hours per charge)
74 lbs \$1,649 each **3Y** **X**

SupaTurf TXE Pro Line Marker

Recognized as the industry standard and ideal for venues with multiple fields.

- > Robust, lightweight, easy to operate
- > 1" to 5" line width capable
- > Battery powered/No engine noise or pollution
- > Handlebar controls
- > Single lever control switches between clean water and paint mode
- > High pressure spray nozzle
- > Mark multiple fields with a single tank
- > Fold over handle for off-season storage
- > 2.5 liter flush tank uses water to flush filter, pump, pipes, spray line and head
- > Return tank system adjusts pressure at spray nozzle to suit conditions and agitates paint in main tank for consistent line color
- > No need to empty main tank between jobs or sites
- > FREE marking disks included
- > Accessories available at www.jaypro.com

FM-TXE353PRO 7 amp (minimum 2 hours per charge)
69 lbs \$1,779 each **3Y** **X**

FM-TXE606PRO 18 amp (minimum 5 hours per charge)
76 lbs \$1,895 each **3Y** **X**



Exclusively supplied in the U.S. by Jaypro Sports through authorized dealers



Economy Paint Marker

- > 2" to 4" line width
- > 4 wheels
- > Fold in handle for off-season storage
- > Aerosol paint sold separately



FME-501

28 lbs

\$139 each

3Y



Field Marking Wand

Ideal for quick and easy lines.

- > Lightweight
- > Single spray can dispenser
- > Aerosol paint sold separately

FMWAND

5 lbs

\$59 each

3Y



Athletic Field Marking Dust

- > Pure white
- > Pallet of (40) 50 lb bags
- > NCAA compliant
- > Non-toxic/Safe for skin, clothes, turf
- > Call for freight quote

AFMD50

2,060 lbs

\$329 each

FR 1Y



Pro-Stripe Athletic Field Marking Paint

- > Concentrate can be diluted with water
- > Natural and artificial turf-friendly
- > Non-toxic/Halogen-free
- > Safe for players and uniforms
- > Stimulates grass root growth

FSP-5WT

BRIGHT WHITE

5 gal bucket

45 lbs \$59 each

1Y

FSP-5YW

SOCCER YELLOW

5 gal bucket

45 lbs \$95 each

1Y

Aerosol Paint (Case)

- > Universal spray tip included
- > Ozone friendly/Contains no CFCs
- > Call for freight quote
- > More colors available at www.jaypro.com



GL-101

WHITE

18 lbs

(12) 18 oz cans

\$52 case

1Y

GL-107

ROYAL BLUE

18 lbs

(12) 18 oz cans

\$62 case

1Y

GL-108

YELLOW

18 lbs

(12) 18 oz cans

\$62 case

1Y

GL-110

RED

18 lbs

(12) 18 oz cans

\$62 case

1Y

Aerosol Paint (Bulk)

Buy in bulk and save with FREE FREIGHT.

PNTPKG-1

WHITE

Pallet (60 cases)

1,150 lbs

\$2,599 each

FR 1Y



ProLine Layout & Marking System

Quick and economical way to line athletic fields.

- > Durable polypropylene locators
- > Starting tool and 600' cord included
- > Easy restriping year after year

FM-LM1

Baseball

12 pc \$99 kit

1Y

FM-LM2

Soccer

25 pc \$189 kit

1Y

FM-LM4

Lacrosse

14 pc \$109 kit

1Y

FM-LM5

Football

50 pc \$329 kit

1Y

FM-LM0

Replacement Kit

10 pc \$89 kit

1Y



www.jaypro.com
T: 800-243-0533

F: 800-988-3363



Multi-Sport Portable Scoreboard Package

Ideal for multi-sport facilities.

- > 10" LED digital scoring and timer
- > Periods and timeouts included
- > 2.4GHz integrated wireless with handheld controller (WHC-1)
- > Adjustable 8 tone 125db horn
- > Portable caddy for easy transport
- > Board: 6"W x 2'4"H x 4 1/4"D
- > Caddy: 5'6"W x 4'7"H x 2'7"D
- > See chart for powder coat and LED colors
- > Call for freight quote

MSPS-26PKG 255 lbs \$5,395 package

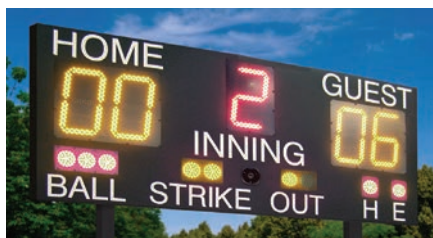

Baseball/ Softball Scoreboard

- > 18" LED digital scoring and innings
- > Balls, strikes, outs, H & E included
- > 2.4GHz integrated wireless
- > Recommended tabletop controller (WTTC-1) sold separately
- > Adjustable 8 tone 125db horn
- > Dimensions: 9"W x 4'H x 4 1/4"D
- > See chart for powder coat and LED colors
- > Call for freight quote

BBSBS-49 120 lbs \$3,895 each

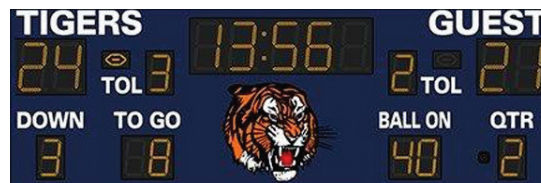

Football Scoreboard

- > 24" LED digital scoring and timer
- > Downs, to go, ball on, quarter, TOL, possession indicator included
- > 2.4GHz integrated wireless with tabletop controller (WTTC-1)
- > Adjustable 8 tone 125db horn
- > Dimensions: 22'4"W x 7'6"H x 4 1/4"D
- > See chart for powder coat and LED colors
- > Call for freight quote

FBS-722 900 lbs \$16,995 each



Basketball Scoreboard

- > 13" LED digital scoring and timer
- > Periods, fouls, TOL, bonus and possession indicators included
- > 2.4GHz integrated wireless with tabletop controller (WTTC-1)
- > Adjustable 8 tone 125db horn
- > Dimensions: 9"W x 5'H x 4 1/4"D
- > See chart for powder coat and LED colors
- > Call for freight quote

BSKS-59 150 lbs \$5,795 each



Lacrosse Scoreboard

- > 18" LED digital scoring, timer and quarter
- > Player, penalty, TOL included
- > 2.4GHz integrated wireless with tabletop controller (WTTC-1)
- > Adjustable 8 tone 125db horn
- > Dimensions: 11"W x 8'2"H x 4 1/4"D
- > See chart for powder coat and LED colors
- > Call for freight quote

LXS-811 290 lbs \$9,195 each



Wireless Tabletop Controller

- > 2.4GHz controller with 1,000 ft operating distance
- > Rechargeable lithium-polymer battery (up to 24 hours between charges)
- > Carry case included
- > Power: DC-5/V, max 1.0 amp, from external power supply or PC
- > Dimensions: 4"W x 12"H x 9"D

WTTC-1
3 lbs \$795 each



Wireless Handheld Controller

- > 2.4GHz controller with 1,000 ft operating distance
- > Power: 2 AA alkaline or rechargeable batteries

WHC-1
1 lb \$345 each



Shot and Play Clock

- > 13" LED digital display
- > 2.4GHz integrated wireless
- > Tabletop controller (WTTC-1) or handheld controller (WHC-1) sold separately
- > Adjustable 8 tone 125db horn
- > Dimensions: 1'9"W x 2'H x 4 1/4"D
- > See chart for powder coat and LED colors
- > Call for freight quote

SPC-2
25 lb \$3,195 set



Enclosure Colors

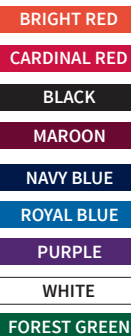

Numerals

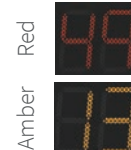

Hack Attack Pitching Machine



Designed for college, high school, youth league and major league play.

- > Speeds of 35-100 mph and distance of 43 ft
- > Unique 3 wheel design changes breaking pitch plane with dial control
- > Underhand feeding motion, acceleration and release emulates a live pitcher
- > Choose from fastballs, risers, drops, right and left-handed screwballs
- > Pivots instantly for pop-ups, fly balls, and grounders
- > Compatible with all ball types
- > Power: 110 VAC – 2000W generator with inverter technology (not included)
- > Arrives assembled

HABPM-100 Baseball 195 lbs \$3,499 each **FR** **1Y**

HASPM-200 Softball 195 lbs \$3,499 each **FR** **1Y**

Hack Attack Junior Pitching Machine



Designed for high school and youth league play.

- > Speeds of 35-70 mph and distance of 43 ft
- > Unique 3 wheel design changes breaking pitch plane with dial control
- > Underhand feeding motion, acceleration and release emulates a live pitcher
- > Choose from fastballs, risers, drops, right and left-handed screwballs
- > Pivots instantly for pop-ups, fly balls, and grounders
- > Compatible with all ball types
- > Power: 110 VAC – 2000W generator with inverter technology (not included)
- > Arrives assembled

HABPM-100JR Baseball Junior 96 lbs \$2,399 each **1Y**

HASPM-200JR Softball Junior 96 lbs \$2,399 each **1Y**

Snap Attack Football Machine



Maximize time on the most difficult to practice phases of the game.

- > Speeds of 70+ mph
- > Distance of 100 yards for passes and punts, 70+ yards for kick-offs, 5 to 15 yards for snap tight spirals
- > Ball release points at 5' for passes and ground level for snaps
- > Simple spiral to kick-off change with elevation control and lever clamp with locating pin
- > Universal ball feed cradle

SAFM-1 165 lbs \$4,199 each **FR** **1Y**

Attack II Volleyball Machine



Maximize daily practice drills with accurate and repeatable reps.

- > Serve receiving, digging, spiking
- > Spike speeds up to 70 mph over women's net
- > Ball release point of 5'6" to 8'6"
- > Simulate match situations with sharp topspins and breaking floaters
- > Ball bags (VBSA-BAG) sold separately
- > Fits through standard doorways and into standard sized SUVs or pick-ups

VBSA-2 200 lbs \$3,149 each **FR** **1Y**

Attack II Ball Bag

Convenient access to volleyballs during machine use.

- > Compatible with Attack II Volleyball Machine (VBSA-2)
- > Holds 15 balls
- > Heavy-duty canvas
- > 2 bags per machine recommended

VBSA-BAG 10 lbs \$149 each **1Y**



Outdoor Square Posts



Acrylic

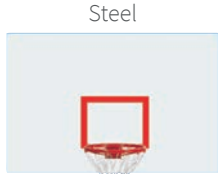

Steel



Perforated

The Titan

- > Fixed height unit buries 48" into ground
- > 6" square steel upright and angled extension arm
- > Acrylic, rectangular or perforated steel backboard choices
- > Backboard and goal mounted directly to extension arm for exceptional strength and reinforced with a rear support brace
- > Available galvanized or powder coated black
- > Heavy-duty goal and nylon net included
- > Bolt-on backboard edge padding (MBBP-6) sold separately
- > Backboard: 72"W x 42"H

Galvanized Post

660-AC-UG	Acrylic Backboard	500 lbs	\$2,195 each
660-RS-UG	Steel Backboard	520 lbs	\$2,195 each
660-PF-UG	Perforated Backboard	500 lbs	\$2,195 each

Black Powder Coated Post

770-AC-UG	Acrylic Backboard	500 lbs	\$2,295 each
770-RS-UG	Steel Backboard	520 lbs	\$2,295 each
770-PF-UG	Perforated Backboard	500 lbs	\$2,295 each

FR ● 3Y



Acrylic



The Church Yard

- > Fixed height unit buries 48" into ground
- > 4" square steel upright and angled extension arm
- > 40" extension arm for "play safe area"
- > Heavy-duty flex goal and nylon net included
- > Post padding and backboard edge padding included
- > Fan backboard (400-FA-FG) does not include edge padding
- > Acrylic Backboard: 48"W x 36"H
- > Aluminum Fan Backboard: 54"W x 36"H

400-AC-FG	Acrylic Backboard	350 lbs	\$1,395 each
400-FA-FG	Aluminum Fan Backboard	300 lbs	\$1,349 each

FR ● 3Y



Double

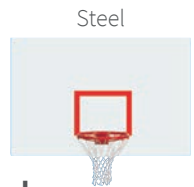

Steel

The Playground

- > Fixed height unit buries 48" into ground
- > Height can be adjusted after court resurfacing or for kids play
- > 6" square steel upright and angled extension arm
- > 66" extension arm for "play safe area"
- > Heavy-duty flex goal and nylon net included
- > Post padding and backboard edge padding included
- > Steel backboard (LS-200RS) does not include edge padding
- > Backboards: 72"W x 42"H

LS-200	Acrylic Backboard	550 lbs	\$2,575 each
LS-200RS	Steel Backboard	550 lbs	\$2,575 each
LD-200	Double Acrylic Backboard	903 lbs	\$3,700 each

FR ● 3Y



www.jaypro.com
T: 800-243-0533 F: 800-988-3363

ClearVIEW

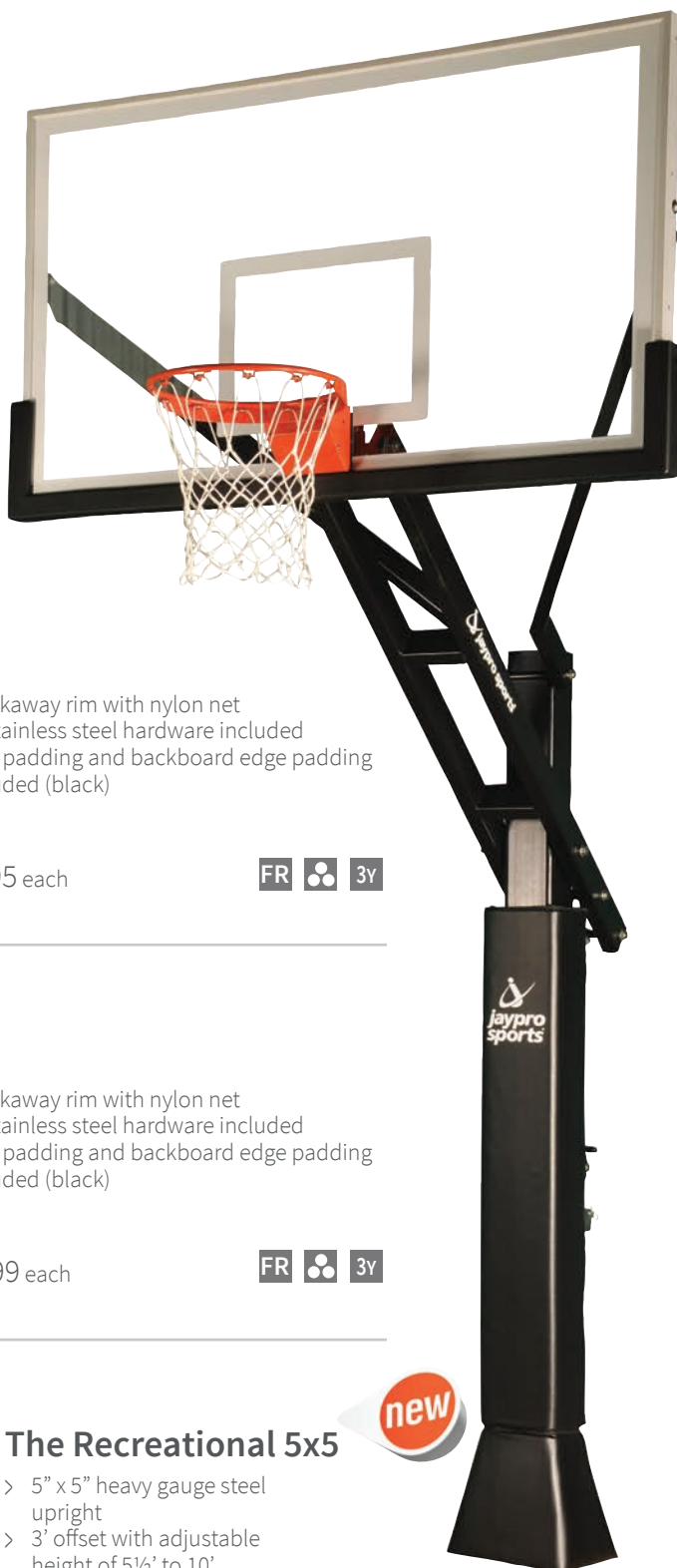

The Recreational 6x8



- > 6" x 8" heavy gauge steel upright
- > 4' offset with adjustable height of 5½' to 10'
- > 42" x 72" tempered glass backboard
- > 2" x 4" heavy gauge steel extension arms
- > Duplex coating "hot dip" galvanized and powder coated black
- > Heavy-duty actuator and safety pin stop

- > Breakaway rim with nylon net
- > All stainless steel hardware included
- > Pole padding and backboard edge padding included (black)

CV684A

623 lbs

\$2,895 each

FR ●● 3Y

The Recreational 6x6



- > 6" x 6" heavy gauge steel upright
- > 4' offset with adjustable height of 5½' to 10'
- > 42" x 72" tempered glass backboard
- > 2" x 4" heavy gauge steel extension arms
- > Duplex coating "hot dip" galvanized and powder coated black
- > Heavy-duty actuator and safety pin stop

- > Breakaway rim with nylon net
- > All stainless steel hardware included
- > Pole padding and backboard edge padding included (black)

CV664A

600 lbs

\$2,499 each

FR ●● 3Y

6" Post Padding

- > Designed for 6" square posts
- > 6'H x 2" thick black padding
- > Attaches to post with hook-and-loop closure

PP-66 18 lbs \$199 each 3Y ★

4" Post Padding

- > Designed for 4" square posts
- > 6'H x 2" thick black padding
- > Attaches to post with hook-and-loop closure

PP-44 3 lbs \$165 each 3Y ★

The Recreational 5x5



- > 5" x 5" heavy gauge steel upright
- > 3' offset with adjustable height of 5½' to 10'
- > 36" x 60" tempered glass backboard
- > 2" x 4" heavy gauge steel extension arms
- > Heavy-duty actuator and safety pin stop
- > Duplex coating "hot dip" galvanized and powder coated black

- > Breakaway rim with nylon net
- > All stainless steel hardware included
- > Pole padding and backboard edge padding included (black)

CV553B

477 lbs

\$1,695 each

FR ●● 3Y



www.jaypro.com
T: 800-243-0533

F: 800-988-3363

Hoop Rejuvenator™



Hoop Rejuvenator™ Kit

Is your basketball gooseneck system leaning, rusting or non-regulation height? Is budget a concern? Upgrade your existing system with the Hoop Rejuvenator™ by Jaypro Sports. Replace rusted backboards or regain regulation heights without the added cost of excavating and replacing your system.

- > Plumbs backboards on leaning goosenecks
- > Designed to fit standard mount plates and gooseneck systems 4½" OD and up
- > Acrylic, rectangular steel or aluminum fan backboard choices
- > H-frame kit or direct mount kit
- > Allows for goal height adjustment after court resurfacing (up to 6" for H-frames and 5" for direct mount units)
- > Ultimate Breakaway Playground Goal (UBG-500F) included
- > Stainless steel hardware and zinc galvanizing spray to cover rust spots included
- > NOTE: 3½" OD goosenecks only use aluminum fan backboard (HRKIT-FA)

FR 3Y X



H-Frame Kit

Acrylic



Aluminum Fan



Steel

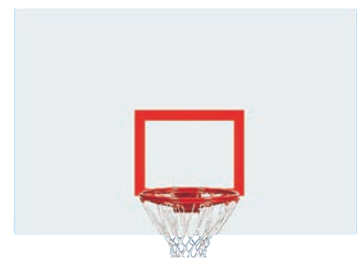

Hoop Rejuvenator™ H-Frame Kit

- > 72" x 42" Rectangular Acrylic Backboard
- > Ultimate Breakaway Playground Goal (UBG-500F)
- > H-frame kit included

FR 3Y

HRKIT-AC 215 lbs \$1,499 each

Hoop Rejuvenator™ H-Frame Kit

- > 54" x 36" Aluminum Fan Backboard
- > Ultimate Breakaway Playground Goal (UBG-500F)
- > H-frame kit included

FR 3Y

HRKIT-FA 119 lbs \$1,249 each

Hoop Rejuvenator™ H-Frame Kit

- > 72" x 42" Rectangular Steel Backboard
- > Ultimate Breakaway Playground Goal (UBG-500F)
- > H-frame kit included

FR 3Y

HRKIT-RC 206 lbs \$1,549 each

Hoop Rejuvenator™ Direct Mount Kit

- > 72" x 42" Rectangular Acrylic Backboard
- > Ultimate Breakaway Playground Goal (UBG-500F)
- > Direct mount kit included

FR 3Y

HRKIT-AC-DIR 190 lbs \$1,299 each

Hoop Rejuvenator™ Direct Mount Kit

- > 54" x 36" Aluminum Fan Backboard
- > Ultimate Breakaway Playground Goal (UBG-500F)
- > Direct mount kit included

FR 3Y

HRKIT-FA-DIR 101 lbs \$1,049 each

Hoop Rejuvenator™ Direct Mount Kit

- > 72" x 42" Rectangular Steel Backboard
- > Ultimate Breakaway Playground Goal (UBG-500F)
- > Direct mount kit included

FR 3Y

HRKIT-RC-DIR 185 lbs \$1,299 each



www.jaypro.com
T: 800-243-0533 F: 800-988-3363

T: 800-243-0533

Ultimate Adjustable Gooseneck

Ultimate Adjustable Gooseneck with Hoop Rejuvenator™

A complete adjustable gooseneck system with the benefits of a Hoop Rejuvenator™ kit.

- > 4½" OD heavy-walled galvanized steel upright
- > H-frame style with 48" extension for "play safe area"
- > Acrylic, rectangular steel or aluminum fan backboard
- > Ultimate Breakaway Playground Goal (UBG-500F) included
- > Hoop Rejuvenator™ Kit included

UAG-AC	72" x 42" Rectangular Acrylic Backboard	370 lbs	\$2,249 each
UAG-FA	54" x 36" Aluminum Fan Backboard	274 lbs	\$1,969 each
UAG-RC	72" x 42" Rectangular Steel Backboard	361 lbs	\$2,249 each

FR 3Y X



Acrylic



Aluminum Fan



Steel

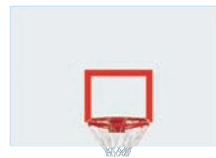

3½" Gooseneck System

- > 3½" OD zinc undercoated steel upright
- > Direct mount style with 36" extension for "play safe area"
- > Backboard and goal mounted directly to extension for exceptional strength
- > Upright galvanized or powder coated
- > Aluminum fan backboard included
- > Single Rim Goal (GB-55) and nylon net included
- > Backboard: 54"W x 36"H

455-FABT-SR-BK	BLACK	144 lbs	\$995 each
455-FABT-SR-RB	ROYAL BLUE	144 lbs	\$995 each
455-FABT-SR-FG	FOREST GREEN	144 lbs	\$995 each
455-FABT-SR	Galvanized	144 lbs	\$895 each

FR 3Y

Basketball Post Padding

- > 30" wide pad wraps around 4½" OD post
- > 4" thick high-density polyurethane foam filler
- > 14 oz vinyl cover with grommet flaps for rear lacing
- > Lacing cord included
- > See chart for vinyl colors
- > Dimensions: 30"W x 6"H

PPP-5HP	9 lbs	FR 3Y ★
\$259 each		



Pro Style Protector Pad

- > 6' tall pad with rear cut-out for easy wrap around gooseneck post
- > Available in sizes to fit 4½" OD or 5⅞" OD posts
- > 6" thick cylindrical high-density polyurethane foam filler
- > 14 oz nylon reinforced vinyl cover with full length hook-and-loop closure flap
- > See chart for vinyl colors

PPP-500HP	4½" OD Pole	15 lbs	\$399 each
PPP-700HP	5⅞" OD Pole	20 lbs	\$479 each

PINK	MAROON
RED	FOREST GREEN
NAVY BLUE	KELLY GREEN
YELLOW	ROYAL BLUE
LIGHT BLUE	TAN
GRAY	PURPLE
BLACK	ORANGE

FR 3Y ★













Outdoor Gooseneck Posts



FR 3Y 1Y



4½" Diameter Gooseneck Post 4' Offset	Super Goal GBSG-50	Double Rim GDR-54	Playground Goal UBG-500	Breakaway Playground UBG-500F
	Aluminum Fan ALB-24BT  277 lbs \$1,195	996-FABT-SG 279 lbs \$1,199	996-FABT-DR 288 lbs \$1,279	996-FABT-UG 290 lbs \$1,349
Steel 850-RB-BB  361 lbs \$1,395	996-RS-SG 363 lbs \$1,399	996-RS-DR 372 lbs \$1,464	996-RS-UB 374 lbs \$1,534	
Perforated Steel SR-PERF  391 lbs \$1,565	996-PERF-SG 343 lbs \$1,570	996-PERF-UG 402 lbs \$1,630	996-PERF-UB 404 lbs \$1,700	
Perforated Aluminum AL-PERF  341 lbs \$1,575	996-ALP-SG 343 lbs \$1,580	996-ALP-UG 352 lbs \$1,640	996-ALP-UB 354 lbs \$1,710	
Acrylic ACRB-72  366 lbs \$1,529	996-AC-SG 369 lbs \$1,534	996-AC-UG 377 lbs \$1,549	996-AC-UB 379 lbs \$1,669	
5⅞" Diameter Gooseneck Post 6' Offset	Super Goal GBSG-50	Double Rim GDR-54	Playground Goal UBG-500	Breakaway Playground UBG-500F
	Aluminum Fan ALB-24BT  357 lbs \$1,780	656-FABT-SG 359 lbs \$1,785	656-FABT-UG 368 lbs \$1,856	656-FABT-UB 370 lbs \$1,926
Steel 850-RB-BB  441 lbs \$2,090	656-RS-SG 443 lbs \$2,095	656-RS-UG 452 lbs \$2,075	656-RS-UB 454 lbs \$2,145	
Perforated Steel SR-PERF  471 lbs \$2,205	656-PERF-SG 473 lbs \$2,210	656-PERF-UG 482 lbs \$2,275	656-PERF-UB 484 lbs \$2,345	
Perforated Aluminum AL-PERF  421 lbs \$2,215	656-ALP-SG 423 lbs \$2,220	656-ALP-UG 432 lbs \$2,285	656-ALP-UB 434 lbs \$2,355	
Acrylic ACRB-72  446 lbs \$2,174	656-AC-SG 448 lbs \$2,179	656-AC-UG 457 lbs \$2,244	656-AC-UB 459 lbs \$2,244	



Outdoor Straight Posts



FR 3Y 1Y

Step 1:

Choose Post



Step 2:

Choose Board



Step 3:

Choose Goal



4 1/2" Diameter Straight Post 4' Offset	Super Goal GBSG-50	Double Rim GDR-54	Playground Goal UBG-500	Breakaway Playground UBG-500F
	Aluminum Fan ALB-24BT	SPA4-FABT-SG 322 lbs \$1,167	SPA4-FABT-DR 324 lbs \$1,172	SPA4-FABT-UG 333 lbs \$1,237
Steel 850-RB-BB	SPA4-RS-SG 406 lbs \$1,467	SPA4-RS-DR 408 lbs \$1,472	SPA4-RS-UG 417 lbs \$1,537	SPA4-RS-UB 419 lbs \$1,607
Perforated Steel SR-PERF	SPA4-PERF-SG 436 lbs \$1,466	SPA4-PERF-DR 438 lbs \$1,471	SPA4-PERF-UG 447 lbs \$1,536	SPA4-PERF-UB 449 lbs \$1,606
Perforated Aluminum AL-PERF	SPA4-ALP-SG 386 lbs \$1,476	SPA4-ALP-DR 388 lbs \$1,481	SPA4-ALP-UG 397 lbs \$1,546	SPA4-ALP-UB 399 lbs \$1,616
Acrylic ACRB-72	SPA4-AC-SG 411 lbs \$1,467	SPA4-AC-DR 413 lbs \$1,472	SPA4-AC-UG 322 lbs \$1,537	SPA4-AC-UB 424 lbs \$1,607
5 9/16" Diameter Straight Post 6' Offset	Super Goal GBSG-50	Double Rim GDR-54	Playground Goal UBG-500	Breakaway Playground UBG-500F
	Aluminum Fan ALB-24BT	SPA6-FABT-SG 402 lbs \$1,680	SPA6-FABT-DR 404 lbs \$1,685	SPA6-FABT-UG 413 lbs \$1,756
Steel 850-RB-BB	SPA6-RS-SG 451 lbs \$1,990	SPA6-RS-DR 453 lbs \$1,995	SPA6-RS-UG 462 lbs \$1,975	SPA6-RS-UB 464 lbs \$2,045
Perforated Steel SR-PERF	SPA6-PERF-SG 481 lbs \$2,105	SPA6-PERF-DR 483 lbs \$2,110	SPA6-PERF-UG 492 lbs \$2,175	SPA6-PERF-UB 494 lbs \$2,245
Perforated Aluminum AL-PERF	SPA6-ALP-SG 431 lbs \$2,115	SPA6-ALP-DR 433 lbs \$2,120	SPA6-ALP-UG 442 lbs \$2,185	SPA6-ALP-UB 444 lbs \$2,255
Acrylic ACRB-72	SPA6-AC-SG 456 lbs \$2,074	SPA6-AC-DR 458 lbs \$2,079	SPA6-AC-UG 467 lbs \$2,144	SPA6-AC-UB 469 lbs \$2,144



Backboards



Unbreakable Replacement Package

- > 42" Unbreakable Glass Backboard (GBRUB-42)
- > Collegiate "Revolution" Goal (GBA-642)
- > Safe-Pro Edge Padding (MBBP-6)
- > Specify edge padding color when ordering

BBRP-42 228 lbs \$1,195 package

Note: The glass itself is not unbreakable. Breakage in transit, during mounting, malicious act or deliberate attempts to damage are not covered under warranty. Boards used with height adjusters below 10' are not covered under warranty.

FR 3Y 1Y



Unbreakable Rectangular Glass Backboard

- > NCAA and NFHS compliant
- > Unique design allows impact load on goal to transfer directly to an engineered lower reinforced steel frame member without putting stress on glass
- > Direct mount (4" x 5" hole pattern) or 4 corner mounting (35½" x 62/66")
- > ½" thick rectangular tempered glass
- > Lightweight high strength clear anodized aluminum channel outer frame
- > Predrilled for Safe-Pro Edge Padding (MBBP-6)
- > Goal and net sold separately

GBRUB-42 72" x 42" Backboard 185 lbs \$899 each

GBRUB-54 54" x 42" Backboard 160 lbs \$695 each

FR 3Y

Note: The glass itself is not unbreakable. Breakage in transit, during mounting, malicious act or deliberate attempts to damage are not covered under warranty. Boards used with height adjusters below 10' are not covered under warranty.

48" Rectangular Glass Backboard

- > Similar features to the Unbreakable Glass Rectangular Backboard
- > Direct mount (5" x 5" hole pattern) or 4 corner mounting (42" x 63/66")
- > Goal and net sold separately

GBAFR-48 72" x 48" Backboard 200 lbs \$899 each

FR 3Y

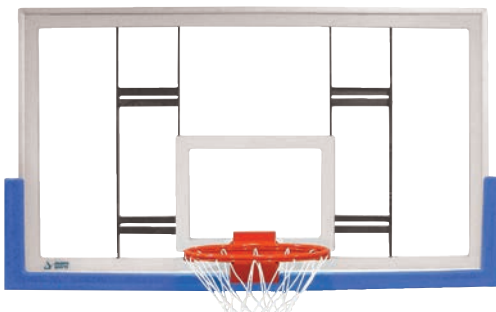

42" Rectangular Glass Conversion Backboard

- > NCAA and NFHS compliant
- > Converts fan-shaped backboard to rectangular backboard
- > Eliminates need to alter playing court or backstop system
- > Direct mount (4" x 5" hole pattern) or 4 corner mounting (20" x 35")
- > ½" thick rectangular tempered glass
- > High-strength clear anodized aluminum frame
- > Goal and net sold separately
- > Backboard: 72"W x 42"H

GCBB-35 230 lbs \$1,145 each

FR 3Y



Patented Perforated Polycarbonate Backboard

- > Retrofits most indoor/outdoor support structures
- > ½" thick polycarbonate backboard is shatterproof
- > 250x stronger and 30% lighter than conventional glass backboards
- > Perforated holes release ball's energy achieving a "true bounce" off backboard
- > Sound and wind resistant construction
- > Graffiti, UVF and scratch resistant coating
- > Available in 3 sizes
- > See chart for custom trim colors
- > Goal and net sold separately
- > Call for freight quote

RED
ATHLETIC GOLD
GRAY
BLACK
BURGUNDY
FOREST GREEN
PURPLE
ROYAL BLUE
WHITE
ORANGE

3654CB 54" x 36" Backboard 75 lbs \$1,509 each

4272CB 72" x 42" Backboard 130 lbs \$2,075 each

4872CB 72" x 48" Backboard 150 lbs \$2,095 each

FR 1Y ★





42" Rectangular Acrylic Backboard

- > 5" x 5" goal mounting pattern
- > Border and target included
- > Goal and net sold separately
- > Dimensions: 72"W x 42"H

ACRB-72M 145 lbs \$869 each **FR** **3Y**



36" Rectangular Acrylic Backboard

- > 5" x 5" goal mounting pattern
- > Border and target included
- > Goal and net sold separately
- > Dimensions: 48"W x 36"H

LS-44AB 99 lbs \$649 each **FR** **3Y**



42" Rectangular Perforated Steel Backboard

- > 5" x 5" goal mounting pattern
- > Rear support frame allows for multiple mounting conversions
- > 11 gauge steel face with 1/4" dia perforations provides open area to minimize wind resistance
- > Goal and net sold separately
- > Dimensions: 72"W x 42"H

SR-PERF 133 lbs \$825 each **FR** **3Y**

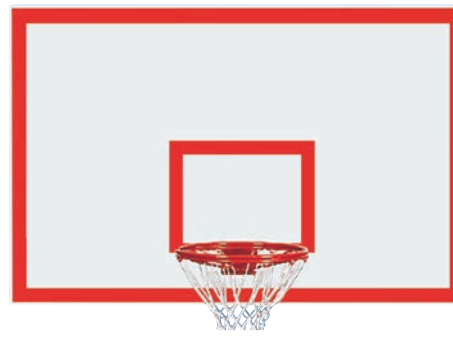

42" Rectangular Steel Backboard

- > 5" x 5" goal mounting pattern
- > Rear welded mounting pattern (35" x 20")
- > 12 gauge steel
- > Goal and net sold separately
- > Dimensions: 72"W x 42"H

850RB-BB-BT w/ Border & Target 200 lbs \$825 each **FR** **3Y**

850RB-BB w/ Target 200 lbs \$787 each



42" Rectangular Perforated Aluminum Backboard

- > 5" x 5" goal mounting pattern
- > Rear support frame allows for multiple mounting conversions
- > Aluminum face with 1/4" dia perforations provides open area to minimize wind resistance
- > Goal and net sold separately
- > Dimensions: 72"W x 42"H

AL-PERF 83 lbs \$860 each **FR** **3Y**



36" Aluminum Fan Backboard

- > 5" x 5" goal mounting pattern
- > Cast aluminum with 1 1/2" flange
- > Goal and net sold separately
- > Dimensions: 56"W x 36"H

ALB-24BT 56 lbs \$499 each **FR** **3Y**



35" Graphite Backboard

- > 2 3/4" x 3 1/2" goal mounting pattern
- > Rear mounting pattern (17 1/2" x 15 1/2")
- > Recommended goal (G-35) and net sold separately
- > Replacement board for the Little Champ™ backboard adapter
- > Dimensions: 48"W x 35"H

FSGB-1 20 lbs \$224 each **FR** **3Y**

Collegiate Goals

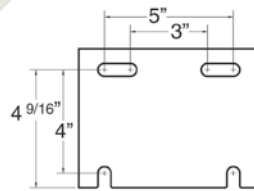

Mounting Plate
(GBA-642, GBA-542)

“Revolution” Breakaway Goal

- > NCAA, NFHS and FIBA compliant and adapts to all levels of play
- > Case hardened wear pin allows rim to safely break from too much pressure
- > Adjust from 140 lbs to 250 lbs
- > Maintains rebound features after 50,000 test cycles
- > Hideaway net attachment system
- > Mounting hardware and anti-whip net included
- > Note: Check existing hole pattern for correct placement

GBA-642	42" Backboard	27 lbs	\$289 each
GBA-648	48" Backboard	27 lbs	\$289 each

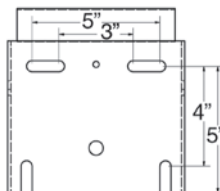

Mounting Plate
(GBA-648, GBA-548)

“Shot” Breakaway Goal

- > NCAA, NFHS and FIBA compliant and adapts to all levels of play
- > Case hardened wear pin allows rim to safely break from too much pressure
- > Adjust from 140 lbs to 250 lbs
- > Maintains rebound features after 50,000 test cycles
- > Pigtail ring net attachment system
- > Mounting hardware and anti-whip net included
- > Note: Check existing hole pattern for correct placement

GBA-542	42" Backboard	27 lbs	\$279 each
GBA-548	48" Backboard	27 lbs	\$279 each



Competitor Goals

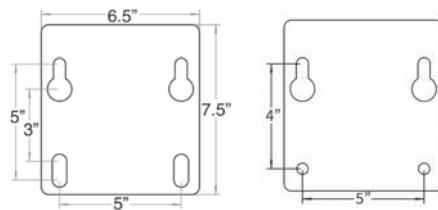

Mounting Plate
(GBA-180)

Mounting Plate
(GBA-18042)

Competitor 180° Breakaway Goal

- > NCAA, NFHS and FIBA compliant
- > Adjustable to withstand different levels or pressure
- > Designed to safely break from any angle
- > Hideaway net attachment system
- > Nylon net and zinc plated mounting hardware included

GBA-18042	42" Backboard	39 lbs	\$485 each
GBA-180	48" Backboard	39 lbs	\$440 each

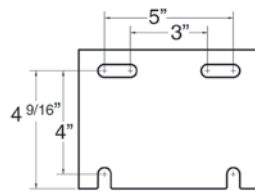

Mounting Plate

Competitor Adjustable Breakaway Goal

- > NCAA and NFHS compliant
- > 5" x 4" goal mounting pattern
- > Adjustable to withstand different levels or pressure
- > Pigtail ring net attachment system
- > Nylon net and mounting hardware included

GBA-342A	42" Backboard	27 lbs	\$247 each
-----------------	---------------	--------	------------

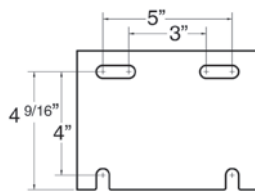

Mounting Plate

Competitor Pro Adjustable Breakaway Goal

- > NCAA and NFHS compliant
- > 5" x 4" goal mounting pattern
- > Adjustable to withstand different levels or pressure
- > Pro level hideaway net attachment system
- > Nylon net and mounting hardware included



GBA-600	25 lbs	\$255 each	
----------------	--------	------------	--



Single Rims

Economy Single Rim Goal

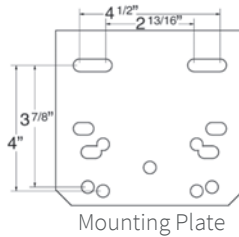

- > Official orange powder coating
- > Nylon net and zinc plated mounting hardware included

G-35 13 lbs \$55 each  



Single Rim Goal

- > Official orange powder coating
- > Official size 18" ring of 5/8" steel with 7/16" round steel brace
- > Universal hole pattern
- > Nylon net and zinc plated mounting hardware included

GB-55 14 lbs \$72 each  

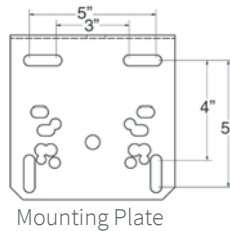

Super Goal

- > Official orange powder coating
- > Official size 5/8" high-tensile alloy rim 1 1/2" times the strength of average rim material
- > Superior support with 5/8" support arms
- > Universal hole pattern
- > Nylon net and zinc plated mounting hardware included

GBSG-50 17 lbs \$125 each  

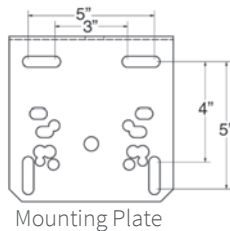

Double Rims

Double Rim Goal

- > Official orange powder coating
- > Official size 18" double ring of 5/8" steel and 1/2" welded together for added strength and rigidity
- > Universal hole pattern
- > Nylon net and zinc plated mounting hardware included

GDR-54 18 lbs \$119 each  

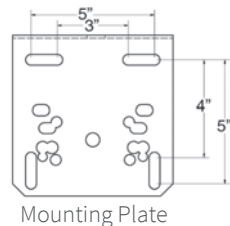

Playground Goal

- > Official orange powder coating
- > Outdoor fixed double solid steel rim
- > No-fail net lock system
- > Universal hole pattern
- > Nylon net included
- > Can be used with a chain net

UBG-500 27 lbs \$179 each  

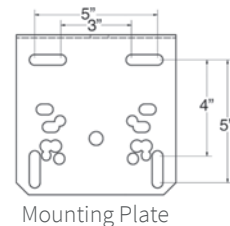

Playground Breakaway Goal

- > Indoor/outdoor use
- > Universal hole pattern
- > Nylon net included
- > Can be used with a chain net

UBG-500F 29 lbs \$225 each  

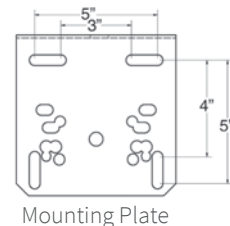

www.jaypro.com
T: 800-243-0533

F: 800-988-3363

Safe-Pro™ a *jaypro sports* product

Safe-Pro™ Edge Padding

- > NCAA, NFHS and FIBA compliant
- > Bolts easily to all 72" official glass backboards
- > Perfect pad alignment with steel connectors
- > Pin style attachment eliminates pad sagging under rim
- > See chart for edge padding colors

MBBP- 6PK	Pink	MBBP- 6FG	Forest Green
MBBP- 6C	Cardinal Red	MBBP- 6OR	Orange
MBBP- 6TO	Burnt Orange	MBBP- 6M	Maroon
MBBP- 6P	Purple	MBBP- 6KG	Kelly Green
MBBP- 6OG	Old Gold	MBBP- 6BK	Black
MBBP- 6RB	Royal Blue	MBBP- 6CB	Columbia Blue
MBBP- 6S	Scarlet Red	MBBP- 6GY	Gray
MBBP- 6NB	Navy Blue	MBBP- 6LP	Light Purple
MBBP- 6YW	Yellow		
MBBP-6	13 lbs	\$197 each	10Y

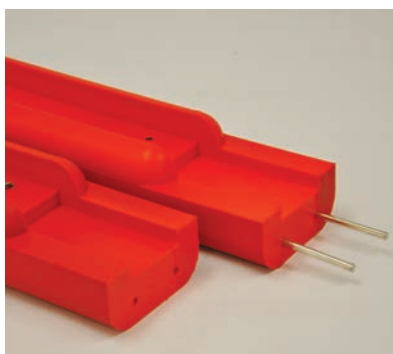

Bolt-on edge padding includes two steel connectors for perfect alignment



Safe-Pro™ 54" Bolt-On Edge Padding

Same features as MBBP-6 except bolts easily to all 54" official glass backboards.

MBBP-54S	Scarlet Red	16 lbs	\$197 each	MBBP-54BK	Black	16 lbs	\$197 each
MBBP-54GY	Gray	16 lbs	\$197 each	MBBP-54RB	Royal Blue	16 lbs	\$197 each



1½" Bolt-On Edge Padding

Designed for wood or acrylic backboards.

- > Fits any 48" acrylic backboard
- > Molded tough "L" shape urethane material
- > Indoor/outdoor use

- > Fits any 72" acrylic or wood backboard
- > Molded tough "L" shape urethane material
- > Indoor/outdoor use

EP-46 Black 9 lbs \$179 each **3Y**

- > Fits any 72" wood backboard
- > Molded tough "U" shape urethane material
- > Indoor/outdoor use

EP-48 Black 9 lbs \$179 each **3Y** **MBBP-WB** Gray 16 lbs \$197 each **3Y**



LED Backboard Light Kit

- > Backboard lights up when shot clock or game time reaches zero and when final segment counts down to zero
- > 5 bright LED strips fit 72"W x 42"H backboards
- > Requires 9VDC-17VDC (formal specified voltage is 10.5VDC)
- > Specify shot clock manufacturer/model when ordering (connects with most shot clocks)
- > Kit includes all items required for your specific shot clock model
- > Connection by a qualified installer recommended
- > Call for freight quote

BB-LED42 25 lbs Call for Pricing **1Y**

Shot Clock Mounting Bracket



- > Designed for Jaypro Sports Elite Portable systems
- > Shot clock not included

PBEL-SCBEA
30 lbs \$359 each

3Y



Basketball Court Stencil

- > Precision cut stencils
- > Easily paint a regulation basketball court on a driveway, patio or play area
- > Paint roller included
- > Finished Court Size: 21'W x 13'L

BCS-1 5 lbs \$49 each **1Y**

Possession Indicator



- > Red LED display in a durable plastic case
- > Toggle switch operation, top red indicator lights and AC adapter with 15' long cord

POSIND1 3 lbs \$141 each **3Y**

Tabletop Scoreboard

- > Rear control panel with visual display
- > Amber and gold LED lights
- > Scores up to 199 and timer up/down to 99:59
- > Buzzer sounds automatically/manually at end of period
- > Uses 110v with 15' power cord
- > Dimensions: 24"W x 15"H x 10"D

TTS10 12 lbs \$679 each **3Y**



Digital display control panel on back for operator



Shooters Ring

- > Creates smaller diameter rim for shooting practice
- > Attaches to standard basketball goals
- > Metal ring design requires no tools for quick and easy installation

SHOTRING 5 lbs \$25 each **3Y**



Rebound Ring

- > Designed to develop rebounding skills
- > Keep balls from falling through rim
- > Attaches to 18" goal with 3 screws

RBRING 3 lbs \$25 each **3Y**



Hideaway Rim Steel Replacement Ring

- > For any rim with hideaway net attachment system
- > Easily slide through brackets to attach net

BBSR-R 1 lb \$13 each **3Y**

Nylon Net

12 loop, 680/32 braided white

JNY-4HP 1 lb \$5 each **1Y**

Anti-Whip Nylon Net

12 loop, 120 threaded, braided cord stops from flipping onto rim

JNY-6HP 1 lb \$14 each **1Y**

Standard Chain Net

Heavy-duty "S" hooks, fits any style goal

J-3 2 lbs \$29 each **3Y**

Removable Goal Bracket Kit

Ideal for park and recreation courts.

- > Stop theft, potential damage and unwanted play
- > Stainless steel bracket fits most front mount backboards with 5" x 5" goal mounting pattern
- > Recommended for GB-55, GBSG-50 or GDR-54 goals
- > Bracket, hardware and padlock included
- > Note: Not to be used with breakaway goals

GAK-5 5 lbs \$61 each **3Y**



Portable Indoor Systems



ELITE 9600



Elite 9600 Portable System

- > Folds down to compact storage position
- > Designed to fit through standard double size doorways (heightwise) with 76" width
- > Spring assisted one person set-up
- > Stabilizing front foot pads independently adjustable for leveling system
- > Adjusts 8' to 10' from floor (6" increments)
- > 96" extension arm for "play safe area"
- > 72" x 42" unbreakable glass rectangular backboard
- > Direct mount 180° breakaway goal
- > Bolt-on backboard edge padding (specify color when ordering)
- > Portable system vinyl padding - see chart on page 85 for vinyl colors (specify when ordering)
- > Optional graphics on padding available - call customer service for details and pricing
- > (6) 8" dia non-marking non-skid wheels - double rear wheels
- > Rear anchor kit included to meet NCAA and NFHS rules for portable competition goals
- > 1000 lb ballast weight included
- > Flatbed tow truck, forklift or loading dock required to unload this product

PBEL96 2600 lbs \$9,150 each **FR** **3Y**

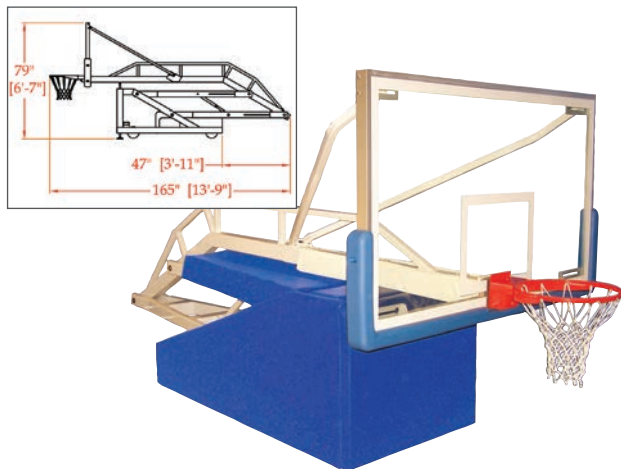

ELITE 6600



Elite 6600 Portable System

- > Folds down to compact storage position
- > Designed to fit through standard doorways with 76" width
- > Spring assisted one person set-up
- > Stabilizing front foot pads independently adjustable for leveling system
- > Adjusts 8' to 10' from floor (6" increments)
- > 66" extension arm for "play safe area"
- > 72" x 42" unbreakable glass rectangular backboard
- > Direct mount "Revolution" breakaway goal
- > Bolt-on backboard edge padding (specify color when ordering)
- > Portable system vinyl padding - see chart on page 85 for vinyl colors (specify when ordering)
- > Optional graphics on padding available - call customer service for details and pricing
- > 8" dia non-marking non-skid wheels
- > Rear anchor kit sold separately
- > 800 lb ballast weight included
- > Flatbed tow truck, forklift or loading dock required to unload this product

PBEL66 2400 lbs \$8,100 each **FR** **3Y**

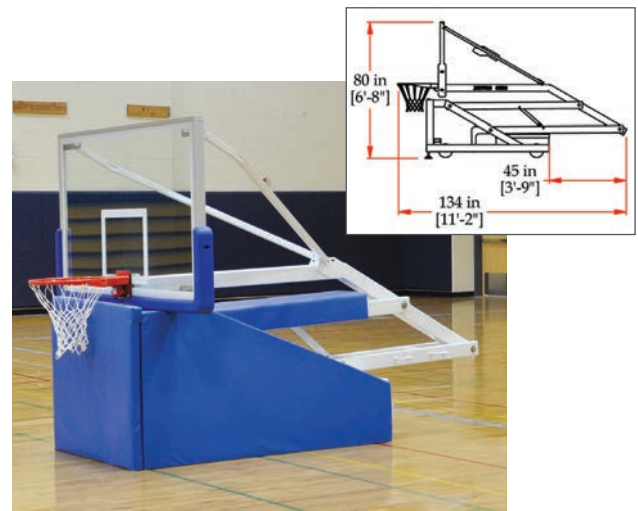



ELITE 5400



Elite 5400 Portable System

- > Folds down to compact storage position
- > Designed to fit through standard doorways with 58" width (PBEL54) or 76" width (PBEL5472)
- > Spring assisted one person set-up
- > Stabilizing front foot pads independently adjustable for leveling system
- > Adjusts 8' to 10' from floor (6" increments)
- > 54" extension arm for "play safe area"
- > 54" x 42" unbreakable glass rectangular backboard
- > Direct mount "Revolution" breakaway goal
- > Bolt-on backboard edge padding (specify color when ordering)
- > Portable system vinyl padding - see chart on page 85 for vinyl colors (specify when ordering)
- > Optional graphics on padding available - call customer service for details and pricing
- > 8" dia non-marking non-skid wheels
- > Rear anchor kit sold separately
- > 800 lb ballast weight included
- > Flatbed tow truck, forklift or loading dock required to unload this product

PBEL54 54" x 42" Backboard 1600 lbs \$6,600 each

PBEL5472 72" x 42" Backboard 1850 lbs \$7,350 each

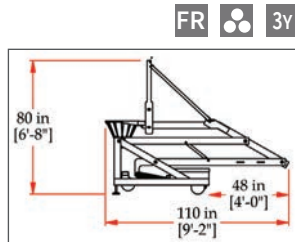

FR ● 3Y

Rear Anchor Kit

3Y

- > Threaded floor anchor
- > Includes all hardware to attach to built-in rear eye bolt

PBELKIT-100 For floating wood floors 3 lbs \$215 each

PBELKIT-89 For other type floors 3 lbs \$215 each



Portable Basketball System

Designed to meet the demands of adult recreation with the flexibility to meet the needs of elementary level activities.

- > Folds down to compact storage position
- > Designed to fit through standard doorways with 48" width
- > Height setting adjusts from 6'6" to 10' - no tools required
- > 48" extension arm at 10' high for "play safe area"
- > 48" x 32" x 3/8" acrylic backboard
- > Direct mount "Revolution" breakaway goal
- > Black backboard edge padding sold separately
- > Portable system vinyl padding - see chart on page 85 for vinyl colors (specify when ordering)
- > Rear anchor kit sold separately
- > Customer supplied ballast required is 300-350 lbs
- > Flatbed tow truck, forklift or loading dock required to unload this product
- > Some assembly required

PBB-200 System 500 lbs \$2,895 each FR ● 3Y

EP-48 Backboard Edge Padding (black only) 16 lbs \$179 each 3Y

AB-4832 Replacement Backboard - 32" x 48" 75 lbs \$425 each 3Y

WARNING! Failure to install customer supplied ballast according to instruction provided could result in serious injury.

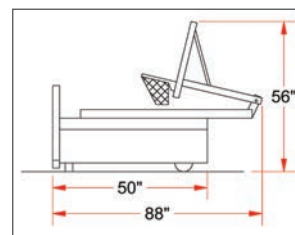

www.jaypro.com
T: 800-243-0533

F: 800-988-3363

Wall Mounted Backstops

Telescoping frames allow for precise positioning of the backboard off the wall.

System comes complete and ready for installation – no cutting of pipes is necessary for units over 4' face of bank (some drilling is required). Attractive silver semi-gloss powder coated finish on all frame pipes and steel fittings.

2" x 8" Southern Yellow Pine mounting wood boards are ready for use: drilled and counter-bored, edges rounded and surfaces sanded with lacquer finished front, back and all edges. (Optional vertical wood stringers available, call for information).

Heavy-walled 1.90" and 1.66" OD frame pipes. Smaller OD pipe telescopes into larger OD pipe for up to 48" of adjustability at time of install.

Jaypro Sports Exclusive Feature: Heavy-duty stamped steel fittings with four 1/2" attachment bolts and grade 5 steel hinge bolts.

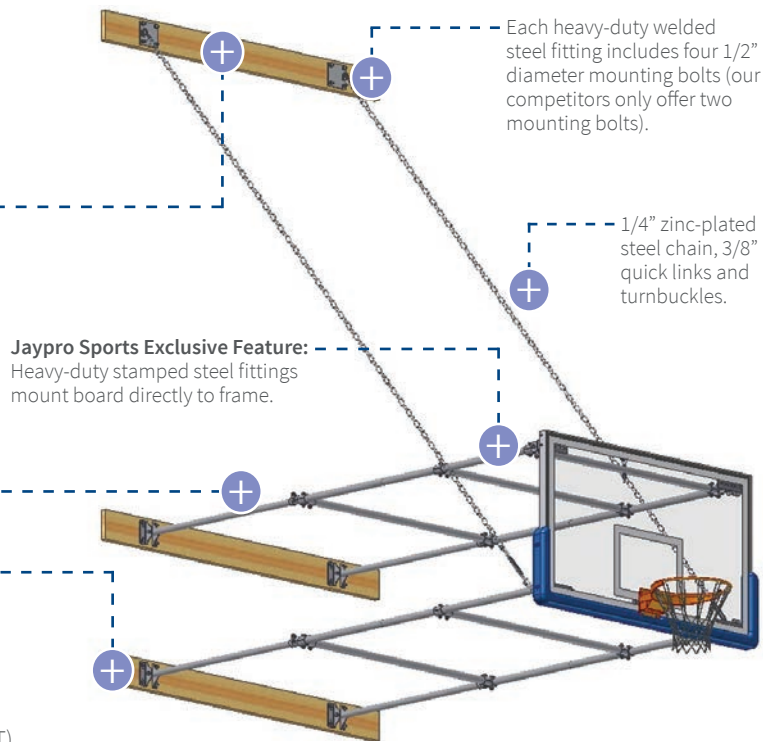

Choice of:

- > 42" Unbreakable Rectangular Glass Backboard (GBRUB-42) or 36" Aluminum Fan Backboard (ALB-24BT)
- > "Revolution" Breakaway Goal (GBA-642) for glass backboard or "Shot" Breakaway Goal (GBA-542) for fan backboard

Options include:

- > Color edge padding - see page 92
- > Height adjuster - see page 99

Wall Anchors not included (order separately depending on your wall construction)

Height Adjusters for Wall Mounts

Order with Stationary, Fold-Up or Side-Fold Backstops

Ordering Instructions: To order a wall-mounted backstop with a height adjuster, add the part number of the height adjuster style desired as a suffix to the system model number. (Example: ST68GB-EHAPW, Stationary backstop with an electric height adjuster with power wand control).

See page 99 for more height adjuster details.

Manual Height Adjuster

AHA 180 lbs \$1,343 kit **3Y** **X**

Electric Height Adjuster (with Key Switch)

EHAKS 195 lbs \$2,576 kit **3Y** **X**

Electric Height Adjuster (with Power Wand Control)

EHAPW 200 lbs \$2,674 kit **3Y** **X**

Note: Power wand control sold separately

Stationary Backstop System

Economical non-folding wall mounted backstop.



Wall to Face of Backboard	42" Glass Board	Price	Aluminum Fan Board	Price
2'-4' Extension	ST24GB	\$1,695	ST24FA	\$1,595
4'-6' Extension	ST46GB	\$1,895	ST46FA	\$1,795
6'-8' Extension	ST68GB	\$1,995	ST68FA	\$1,895
8'-10' Extension	ST810GB	\$2,295	ST810FA	\$2,195
10'-12' Extension	ST1012GB	\$2,349	ST1012FA	\$2,249

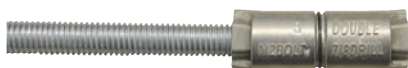

"Double" Dual Expansion Machine Bolt Wall Anchor

For solid concrete walls, including pre-cast concrete or filled block.

- HM2711** \$7 each **3Y**
- SR5187** 1/2" Threaded Rod - 12" Long \$5 each **3Y**
- SR5276** 1/2" Threaded Rod - 18" Long \$5 each **3Y**

No. 1 Type Tumble Toggle Wall Anchor

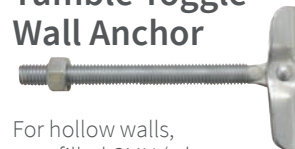

For hollow walls, non-filled CMU (when anchoring into hollow block wall).

- HM6212** \$6 each **3Y**

Safe-Pro Edge Padding



See page 92 for details about this product.

Fold-Up Backstop System

- > Backboard folds up against wall for convenient storage
- > Backstop is raised and lowered by manual winch (TW-700M) or electric winch (TW-2000-1) - both winches sold separately
- > Adequate ceiling height required to accommodate backstop in folded position
- > Use of safe straps (PL-1000) on all units recommended
- > Optional height adjuster sold separately

FR   3Y 

Wall to Face of Backboard	42" Glass Board	Price	Aluminum Fan Board	Price
4'-6' Extension	FU46GB	\$2,349	FU46FA	\$2,249
6'-8' Extension	FU68GB	\$2,395	FU68FA	\$2,295
8'-10' Extension	FU810GB	\$2,695	FU810FA	\$2,595
10'-12' Extension	FU1012GB	\$2,749	FU1012FA	\$2,649



Electric Winch with Wall Mounting Kit

- > Electric winch (TW-2000)
- > Finished wood mounting boards and hardware

TW-2000KT1 \$1,395 each
FR   3Y

Manual Winch with Wall Mounting Kit

- > Manual winch (TW-700M)
- > Finished wood mounting boards and hardware
- > Manual winch handle sold separately

TW-700MKT1 \$798 each
FR   3Y

Safety Strap with Wall Mounting Kit

- > Safety strap (PL-1000)
- > Finished wood mounting boards and hardware

PL-1000KT1 \$625 each
FR   3Y

Side Fold Backstop System

- > Backboard folds to side against wall for convenient storage
- > May be built to fold in either direction
- > Spring-loaded locking pin holds backstop in both playing and stored position
- > Adequate ceiling height and wall clearance required to accommodate backstop in side folded position
- > Optional height adjuster sold separately

FR   3Y 

Wall to Face of Backboard	42" Glass Board	Price	Aluminum Fan Board	Price
4'-6' Extension	SF46GB	\$1,949	SF46FA	\$1,849
6'-8' Extension	SF68GB	\$1,995	SF68FA	\$1,895
8'-10' Extension	SF810GB	\$2,195	SF810FA	\$2,095
10'-12' Extension	SF1012GB	\$2,249	SF1012FA	\$2,149



IMPORTANT NOTES FOR WALL MOUNTED BACKSTOPS:

1. Wall-mounted basketball systems should only be installed on walls capable of supporting the weight of the backstop plus the additional weight of a player hanging off the rim. If you are unsure if your wall is capable of handling such loads, consult an architect, structural engineer or contractor.

2. Wall-mounted basketball systems require a minimum ceiling height and unobstructed wall height, depending on distance from the wall. Please refer to the backstop dimensional drawings and charts on www.jaypro.com or call customer service.

3. Jaypro Sports bears no responsibility for the structural integrity of the walls these backstops are mounted to.

4. Installation should only be done by a qualified installer using suitable wall anchors. Please contact Jaypro Sports for assistance in locating a qualified installer.

5. Jaypro Sports recommends two types of wall anchors depending on whether the anchoring is done into solid concrete or hollow block. When anchoring to un-filled CMU walls, often both anchors are required. Order wall anchors separately.

6. Jaypro Sports recommends all basketball backstops be inspected on an annual basis to ensure all wall anchors are sound, fasteners are secured and cables are not worn. Please contact Jaypro Sports for assistance in locating a qualified installer.



Shooting Stations



Wall Mount Shooting Station

Ideal for young children learning shooting skills and the art of free throws.

- > 3' Face of Bank
- > Handle easily adjusts backboard to desired height between 8' and 10'
- > Unbreakable Glass Rectangular Backboard (GBRUB-42)
- > "Revolution" Breakaway Goal (GBA-642) with hideaway net attachment
- > Wood backing included
- > Backboard edge padding and mounting hardware sold separately

WMWH	Station with Height Adjuster	440 lbs	\$2,795 each	FR	3Y	1Y
WMSS	Station without Height Adjuster	285 lbs	\$1,995 each	FR	3Y	1Y



Adjustable Wall Mount Shooting Station

- > Indoor/outdoor use
- > Hand crank adjusts backboard to desired height between 7½' and 10'
- > Acrylic backboard with aluminum backboard frame available in two sizes
- > Extension from wall to backboard ranges from 33" - 44" depending on height
- > Heavy-duty flex goal with nylon net and black edge padding included
- > Mounting hardware sold separately

WM-48	Backboard - 36" x 48" x 1/2"		\$1,275 each	FR	3Y	1Y
WM-60	Backboard - 36" x 60" x 1/2"		\$1,389 each	FR	3Y	1Y

Safety Strap



Posilok™ Backstop Safety Strap

- > Designed to automatically lock backstop in position should a malfunction occur during raising or lowering of unit
- > Belt capable of withstanding 7,300 lb load
- > Visible maximum safe extension patch and Telltale Indicator notifies when safety strap has been called into action
- > Self-checking fail safe check mechanism, automatic rest, stronger clamping system and versatile mounting features included

PL-1000		17 lbs	\$659 each	1Y
----------------	--	--------	------------	-----------

Backstop Winches

Direct Drive Backstop Winch

- > Designed to raise and lower basketball units
- > Instantly reversing 1 HP 115 volt single phase torque motor
- > Motor delivers at least 800 pounds of line pull at a speed of 11'/minute
- > Unidirectional worm brake and self-locking worm drive
- > Universal mounting bracket to fit 3½" OD pipe included
- > Maintenance free operation with no belts or chains
- > Optional 3 position key switch (KS-13) sold separately
- > Remote receivers and control systems sold separately

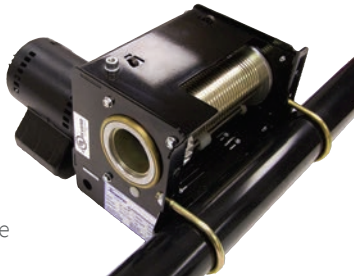

TW-2000-1	Winch	72 lbs	\$1,300 each (+ any req hardware/cables)	1Y
KS-13	Key Switch	2 lbs	\$99 each	1Y

Radio Remote Receiver

DRX-1199	\$409 each	1Y
-----------------	------------	-----------



Radio Remote Transmitter

TMX-1199	\$225 each	1Y
-----------------	------------	-----------



Manual Winch

- > Compact and easy-to-use
- > Self-lubricating composite gears eliminate need for oil
- > Unique worm brake and grooved drum helps prevent back-drive and cable kinking
- > Cable retention roller prevents unspooling of cable
- > Handle (TW700H) sold separately
- > Note: Not for use on backstops with a ceiling height over 27'



TW-700M	Winch	24 lbs	\$725 each	1Y
TW-700MKT1	Winch w/ Wall Mounting Kit		\$798 each	1Y
TW700H	Handle		\$299 each	1Y

Manual Winch Operator

Designed for use with Manual Winch (TW-700M).

- > Heavy-duty portable winch operator raises and lowers all types of backstops



ED-902		19 lbs	\$799 each	1Y
---------------	--	--------	------------	-----------



Height Adjusters Overview

Why Use a Jaypro Sports Height Adjuster?

Adjust the height of your backboard and rim from 8' to 10'. Lightweight and easy to operate. Constructed of extruded aluminum interlocking channels, which provide tighter clearances resulting in less shake than other height adjusters on the market – even at the lower playing heights. Choose either manual operation or electric control. The electric height adjuster is driven by a 1/6 HP motor, requiring 120 volt power. Electric height adjusters may be hard wired, or temporarily powered off a standard 120 volt electric wall outlet.

What Are the Different Types of Jaypro Sports Height Adjusters?

Manual Height Adjusters (Model: AHA): Easily raises and lowers the backboard with a manual hand crank. The manual height adjuster may also be controlled using a portable Cordless Drill Operator (CD-80H) purchased separately.

Electric Height Adjuster with Key Switch Control (Model: EHAKS): Requires running a dedicated 120 volt, 15 amp circuit to the wall mounted key switch and motor. Three position, momentary operated key switch provided.

Electric Height Adjuster with Power Wand Control (Model: EHAPW): Control your electric height adjuster without the added expense of hard wiring. Does not require an electrician or permanent electric wiring. Height adjuster comes with a built-in power wand receptacle. To operate, plug Power Wand into receptacle and any 120 volt, 15/20 amp wall outlet.



The narrow profile of the AHA height adjuster maintains a visually clean target area



Power Wand Controller

- > Portable handheld controller
- > Plugs into standard 120 volt (15/20 amp electrical wall outlet)
- > Operates by moving momentary toggle switch to desired position

HAPW-100 10 lbs \$460 each **3Y**



Manual Hand Crank

Replacement hand crank for manual height adjuster (6' long).

HA-1H 5 lbs \$99 each **3Y**

Cordless Manual Height Adjuster Operator

- > Heavy-duty 18 volt cordless drill for operating the Manual Height Adjuster (AHA-XX)
- > Charger, two batteries and carry/storage case included

CD-80H 18 lbs \$780 each **3Y**





Height Adjusters for Existing Systems

Take the guess work out of how to add a height adjuster to an existing backstop.



- > Kit fits most common backstop frames
- > Height adjuster (choose manual or electric)
- > 42" unbreakable glass rectangular backboard (GBRUB-42)
- > "Revolution" breakaway goal (GBA-642)
- > Mounting hardware to attach to center strut (6" OD to 6 5/8" OD) or double drop (H-frame) backstops included

To order choose your style of backstop and desired height adjuster. Double drop kits have mounting holes drilled in the field so they can fit most any frame width. Call customer service if you have any configuration not listed below.

For Center Strut Frames:

GBCS-AHA	Manual Adjuster	FR  3Y
330 lbs	\$1,800 kit	
GBCS-EHAKS	Electric Adjuster w/ Key Switch	FR  3Y
345 lbs	\$3,121 kit	
GBCS-EHAPW	Electric Adjuster w/ Power Wand Control	FR  3Y
350 lbs	\$3,219 kit	

For Double Drop Frames:

GBDD-AHA	Manual Adjuster	FR  3Y
400 lbs	\$1,981 kit	
GBDD-EHAKS	Electric Adjuster w/ Key Switch	FR  3Y
415 lbs	\$3,214 kit	
GBDD-EHAPW	Electric Adjuster w/ Power Wand Control	FR  3Y
420 lbs	\$3,312 kit	

Center Strut Frame



Double Drop Frame



Facility Accessories



Gym Guard Floor Cover

- > Protect gymnasium floor during non-athletic events with durable 3-ply fabric
- > Flame retardant, anti-bacterial, antifungal and rot/mildew resistant
- > Meets California Fire Marshal specifications
- > 6"-12" overlap for each section recommended
- > 10' wide sections for easy handling
- > 5' wide minimum charge (specific dimensions needed when ordering)
- > See chart for colors (specify when ordering)
- > Note: 18 oz only available in solid colors
- > Call for freight quote

FR 1Y ★

GGFPS-16	18 oz Floor Cover	\$0.90 sq ft
GGFPS-22	22 oz Floor Cover	\$1.05 sq ft
GGFPS-24	27 oz Floor Cover	\$1.25 sq ft

TAN	RED	NAVY BLUE
BROWN/TAN	GREEN	DARK GRAY
ROYAL BLUE	BURGUNDY	BLACK
TAN/ROYAL	TAN/BURGUNDY	ORANGE
LIGHT GRAY	KELLY GREEN	YELLOW

Safety Storage Rack

- > All steel construction
- > 8" dia non-marking wheels lock and swivel
- > 2 hand cranks included
- > Call for freight quote

FR 1Y ★

MSR-6	6 Roll Rack	\$2,999 each
MSR-8	8 Roll Rack	\$3,449 each
MSR-10	10 Roll Rack	\$3,649 each



Keyclean Pro

- > 2 large 18" x 24" mops made with highly absorbent microfiber pads
- > 6' adjustable two-piece aluminum handle
- > Fast drying and slip resistant to reduce injuries and reduces refinishing frequency
- > 2 mops and 2 pads included
- > Call for freight quote

3Y



Courtclean

- > Get a safe, clean floor in minutes with this damp mop system.
- > 6' mop made of rotationally molded linear density polyethylene material
- > Built-in carrying handle, hook-and-loop fasteners to keep towel in place and sturdy metal pull strap fastener included
- > Replacement towels sold separately
- > Call for freight quote

3Y

Item	Description	Price
CCM-6	6' Courtclean Mop	\$499 each
CCT-6	6' Courtclean Towel	\$44 each
KCP-1	Keyclean Pro Set	\$325 each
KCPD-2	Keyclean Pro Pads	\$75 pair
CCSS-1	1 gal Super Shine-All	\$50 each
CCSK-6	6' Start Up Kit	\$179 each

Scorer Table

- > Illuminated table (120VAC, 60Hz) comfortably sits 3-4 people
- > Available in free standing or bleacher mount style and in 8' or 10' lengths
- > Tabletop includes multiple cup holders and folds vertically for storage
- > Large access holes in tabletop for console, laptop cords or other electronics
- > Bins under the table hold extension cords, power adapters and other accessories
- > 3" lockable swivel poly wheels
- > Removable shatterproof face panels for multiple sponsors or team logos
- > Customer provides artwork to go on face panels
- > Colors available include Black, Royal Blue, Purple, Dark Green, Maroon, Red or Green (specify when ordering)
- > Call for freight quote



Free Standing	ST-8FS	8' Long	357 lbs	\$3,199 each	FR	3Y
	ST-10FS	10' Long	454 lbs	\$3,399 each	FR	3Y
Bleacher Mount	ST-8BM	8' Long	397 lbs	\$3,649 each	FR	3Y
	ST-10BM	10' Long	637 lbs	\$3,869 each	FR	3Y



Adjustable Wall Mounted Chinning Bar

- > Ideal for elementary through university level use.
- > Provides 2' of height adjustment in 6" increments
- > All-welded 30"W steel frame with powder coat finish

EWM-30 28 lbs \$249 each FR 3Y



Jump Rope Rack

- > Keep jump ropes untangled and ready for use.
- > Wall-mounted all steel construction with powder coat finish
- > 27" long with (5) 10" long pegs

PE-110 5 lbs \$45 each FR 3Y



www.jaypro.com
T: 800-988-3363 F: 800-988-3363

T: 800-243-0533

Note: Due to difference in wall construction. Jaypro Sports does not provide anchors or mounting hardware to attach the wall stringers to gymnasium walls. Consult your architect or contractor to determine the best and safest installation methods for your facility.

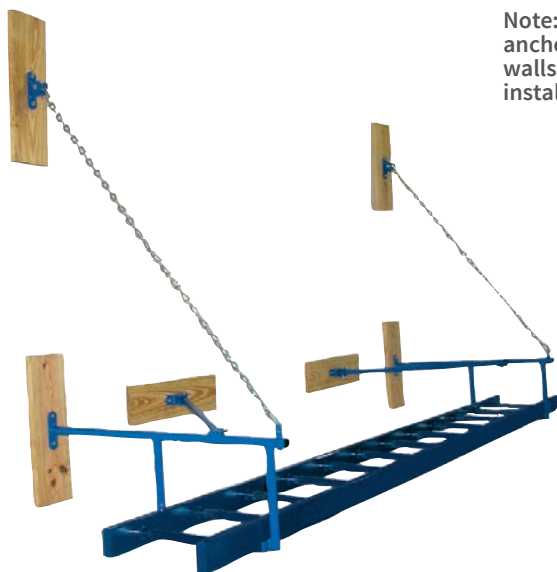

Wall-Mounted Gym Ladder

Ideal for developing physical fitness, strength and coordination.

- > Steel frame with welded supports for strength and durability
- > Powder coated blue finish is textured for safety
- > Inner braces provide stability for lateral movement
- > Ladder is attached with wood stringers (included) and is additionally supported with a heavy duty chain
- > Frame extends 48" from wall
- > Dimensions: 18"W x 12"L

WML-100 187 lbs \$1,595 each FR 3Y

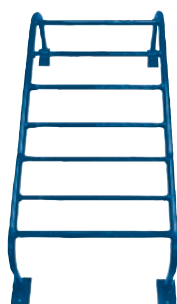

Vertical Climbing Ladder

- > 1 5/16" OD steel tubing construction
- > Powder coated blue finish is textured for safety
- > Heavy-duty wall mounting plates
- > Dimensions: 22"W x 60"L

WVL-7 77 lbs \$339 each FR 3Y



Wall Grid Climber

- > 1 5/16" OD steel tubing construction
- > Powder coated blue finish is textured for safety
- > Grid is 4 x 5 rows with 6" pattern
- > Heavy-duty wall mounting plates

WGC-20 72 lbs \$465 each FR 3Y

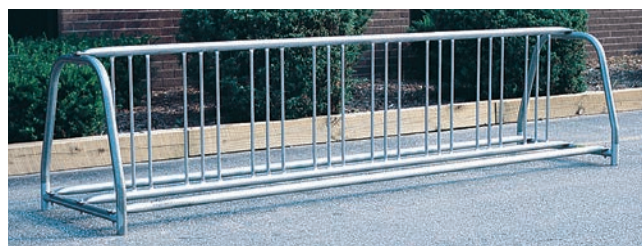

Portable Bicycle Rack

- > Available in 4 sizes and designed to hold bicycles or mopeds
- > 1 5/8" galvanized steel all-welded frame with gray powder coat finish

FR 3Y

Item	Capacity	Size	Weight	Price
OBR-16	16	102"L x 30"W x 30"H	67 lbs	\$619 each
OBR-10	10	67"L x 30"W x 30"H	60 lbs	\$549 each
OBR-8	8	55"L x 30"W x 30"H	56 lbs	\$519 each
OBR-6	6	47"L x 30"W x 30"H	49 lbs	\$479 each

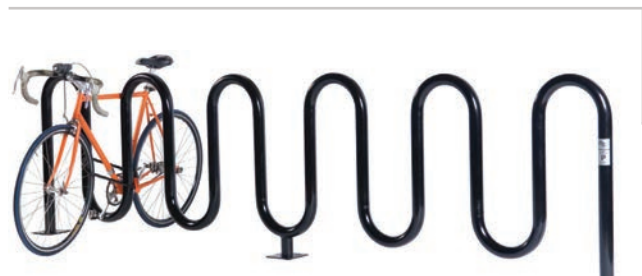

Wave Bicycle Rack

- > Contemporary design
- > 2 3/8" OD Schedule 40 tubing construction
- > 36"H with 12" spacing between waves
- > In ground or surface mount styles available
- > See chart for powder coat colors (specify when ordering) - standard color is black
- > Call for freight quote

FR 1Y

COLUMBIA RED	BROWN	JOHN DEERE YELLOW	DARK GRAY
BEIGE	BRIGHT WHITE	SAFETY YELLOW	GRAY
ESSEX GREEN	BLUE	EMERALD GREEN	BLACK

Below Grade Mount - Galvanized

Item	Capacity	Length	Weight	Galvanized
HDWBR-7	7	64"	74 lbs	\$545 each
HDWBR-9	9	87"	96 lbs	\$745 each

Powder Coated

Item	Powder Coat
HDWBR-7PC	\$545 each
HDWBR-9PC	\$745 each

Surface Mount - Galvanized

Item	Capacity	Length	Weight	Galvanized
HDWBR-7SM	7	64"	74 lbs	\$565 each
HDWBR-9SM	9	87"	96 lbs	\$765 each

Powder Coated

Item	Powder Coat
HDWBR-7SMPC	\$565 each
HDWBR-9SMPC	\$765 each



A Leading Manufacturer of Quality Sports Equipment

With over 65 years of experience, Jaypro Sports continues to develop the most robust and reliable equipment for athletic fields and facilities across the United States.

Complex Projects Are Our Specialty

From gymnasiums to multi-use facilities, Jaypro Sports has a dedicated team with a long history in successfully delivering projects from concept to completion.

An Exceptional Field and Facility Solutions Company

Design

The Custom Projects Team at Jaypro Sports uses cutting edge 3D modeling design and collaborative software to ensure new construction products meet or exceed the highest performance standards. Innovative solutions are designed to meet the most challenging of facility requirements no matter the vision.

Engineering

Engineers on the Custom Projects Team utilize the latest analytical software to assess designs and achieve unsurpassed performance with optimum safety. Jaypro Sports engineers, designers and project managers are well-trained and harness the vision to realize a well-designed athletic facility.

Manufacturing

All team members at Jaypro Sports are dedicated to innovating and manufacturing athletic equipment at the highest standards for fields and facilities across the United States. From possessing a team of skilled and certified welders in our factory to running in-house, state-of-the-art robotic saws, plasma machines and premium powder coating systems, Jaypro Sports takes manufacturing safe and high performance athletic equipment serious.



Athletic Field/Facility New Construction and Renovations

Renovating a facility or upgrading an athletic field is an enormous undertaking. Jaypro Sports eases that burden by bringing over 65 years of real-world experience to the table and implementing superior institutional sports equipment made for champions. The Custom Projects Team assists from start to finish and delivers results to any new construction or facility upgrade project.

Outdoor Complexes

Field Netting • Benches/Bleachers • In-Ground Track
Field Maintenance • Soccer • Football • Baseball
Basketball • Lacrosse/Field Hockey

Indoor Facilities

Divider Curtains • Benches/Bleachers • PE Equipment
Equipment Control Systems • Basketball Backstops
Batting Cages • Volleyball Systems • Wall Padding

Architect Approved Athletic Equipment

Many Jaypro Sports products are architect approved and files are available online to help designers and architects with projects. Visit www.jayprospecs.com to download CSI Specifications, Product Cut Sheets, Installation Instructions, Technical/Architectural Files and more.

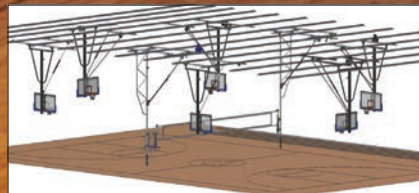

www.jaypro.com
T: 800-243-0533

F: 800-988-3363

Gym Divider Curtains

Jaypro Sports offers a variety of functional and attractive divider curtains that help divide any sports facility or institutional space. From power-controlled to manual curtains, we custom design divider curtains for any facility size requirements. Also available in solid vinyl or vinyl coated mesh with several color options.

Call for details and pricing. ★

Roll Up Curtain: Raised and lowered by heavy-duty hoist belts and stores in a 2' storage space close to the building structure.

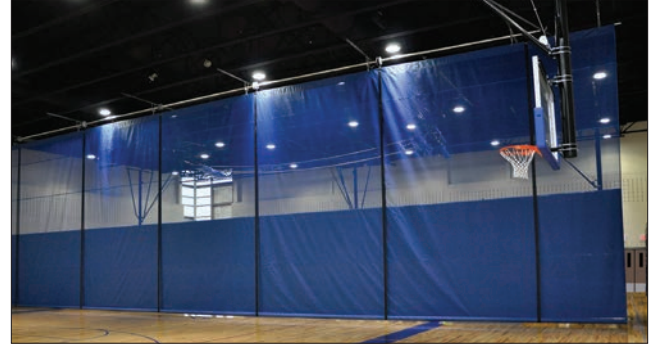

Slope Fold Curtain: Engineered to fit against the roof frame and conform to virtually any slope while providing maximum clearance for all sporting activities.

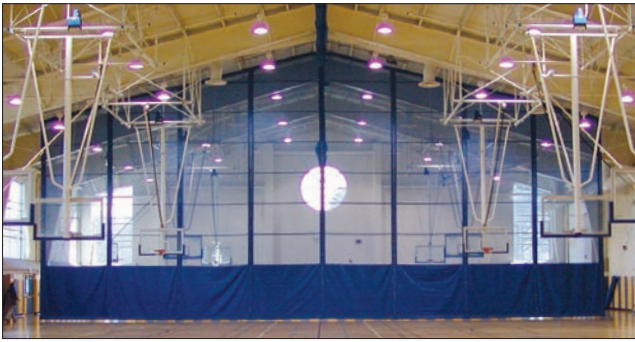

Walk Draw Curtain: Designed for manual operation, this curtain is moved by pulling it along a ceiling suspended track to store along a perimeter wall.

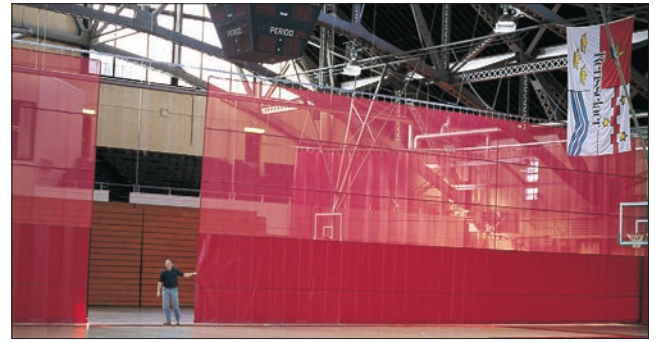

Top Roll Curtain: Uses no hoist cables or straps to raise and lower the curtain and stores tighter than many other curtain designs for additional clearance with low ceilings.



Fold-Up Curtain: Mounted to the building structure, this curtain uses accordion style vertical folding action making it virtually invisible in the raised position.



Mini Top Roll Curtain



Mini Top Roll Curtain

- > Use in different locations to create closed off areas
- > Designed to be compact and tight fitting to ceiling structure
- > Disappears up into or behind ceiling structure and rolls down at the touch of a button
- > 14 oz or 18 oz reinforced vinyl and 9 oz vinyl coated polyester mesh
- > Driven by an internal tubular motor requiring 120 volt power
- > Print school graphics or advertising on curtain
- > Developed for and used at Barclay's arena in Brooklyn, NY

TC-710

Call for Pricing and Details

3Y ★

Wrestling Mat Storage System

Double Wrestling Mat Storage System



Securelift™ Wrestling Mat Storage System

- > Eliminate risk of injury to students, athletes and coaches from the manual lifting and transporting of heavy and awkward mats
- > Gain valuable storage space and extend the life of wrestling mat
- > Roll mat(s) onto sling, attach sling to load bar, turn key to raise the unit and store at ceiling height
- > Available in single, double, and mini sizes

MH-D-A

Call Customer Service for Pricing

3Y

Single Wrestling Mat Storage System

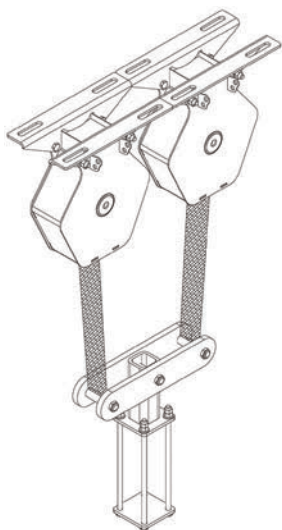

MATLOK™ a **jaypro sports** product

Matlok™ Wrestling Mat Storage System Safety Strap

- > Designed to automatically lock a mat hoist system in position should a malfunction occur
- > Self-checking, self-leveling, fail safe mechanism features
- > System comprised of 2 load bar rocker assemblies and 4 Posilok Safety Straps
- > System adaptable to any wrestling mat storage system
- > Versatile mounting clamps included

MH-MLS

Call for Pricing

3Y



WallGUARD™ a **jaypro sports** product



Four levels of player protection to meet various facility needs and atmospheres.

- › Provides excellent wall protection to absorb player impact
- › Reduces noise levels in any facility
- › Wall padding should be installed on all rigid surfaces located in close proximity (within 10') to active playing areas

Mounting options include:

- › 1" lip, top and bottom
- › Z-clip top, 1" lip bottom
- › Z-clip top and bottom



WallGUARD™ Basic Wall Padding

(Level 1) Padding

- › Economy wall padding for areas where impact is less likely
- › 2" thick polyurethane foam with 7/16" Oriented Strand Board backing
- › 14 oz fire-retardant vinyl in a variety of colors



WallGUARD™ Impact Wall Padding

(Level 2) Padding

- › Optimal for high activity facilities and/or close proximity to activity areas
- › 2" thick high impact foam with 7/16" Oriented Strand Board backing
- › 14 oz fire-retardant vinyl in a variety of colors
- › Exceeds impact standards as defined in ASTM F2440-04



WallGUARD™ Fire Wall Padding

(Level 3) Padding

- › Class A wall padding for areas where impact is less likely
- › 2" thick fire retardant foam with 7/16" Oriented Strand Board backing
- › 14 oz fire-retardant vinyl in a variety of colors
- › Certified class A fire rating in accordance with NFPA 255/ASTM E-84



WallGUARD™ Fire/Impact Wall Padding

(Level 4) Padding

- › Highest rated wall padding for maximum player safety and building protection
- › Optimal for high activity facilities and/or close proximity to activity area
- › 2" thick fire retardant and high impact foam with 7/16" Oriented Strand Board backing
- › 14 oz fire-retardant vinyl in a variety of colors
- › Exceeds impact standards as defined in ASTM F2440-04
- › Certified class A fire rating in accordance with NFPA 255/ASTM E-84



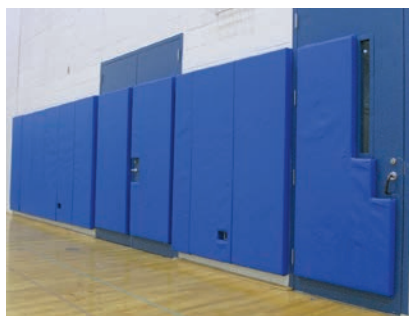

Custom Sizes • Custom Lettering • Custom Graphics • Eco-Friendly Wall Pads
Outdoor Wall Pads • Column Pads • Corner Pads • I-Beam Wraps • Stage Padding

WallGUARD™ Basic

FR 1Y ★

Item	Size	Description	Weight	Price
JWCF-B-2472	2' x 6'	Basic w/1" lip top & bottom	26 lbs	\$125 each
JWCF-B-2472Z	2' x 6'	Basic w/z-clip lip	26 lbs	\$135 each
JWCF-B-2472ZZ	2' x 6'	Basic w/z-clip top & bottom	26 lbs	\$145 each

Available in 2'W x 6'H panels

Call for Details and Pricing

WallGUARD™ Impact

FR 1Y ★

Item	Size	Description	Weight	Price
JWCF-I-2472	2' x 6'	Impact w/1" lip top & bottom	26 lbs	\$139 each
JWCF-I-2472Z	2' x 6'	Impact w/z-clip lip	26 lbs	\$149 each
JWCF-I-2472ZZ	2' x 6'	Impact w/z-clip top & bottom	26 lbs	\$159 each

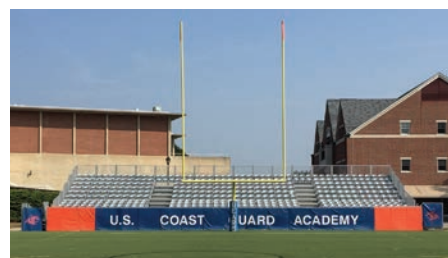

WallGUARD™ Fire

FR 1Y ★

Item	Size	Description	Weight	Price
JWCF-A-2472	2' x 6'	Fire w/1" lip top & bottom	33 lbs	\$199 each
JWCF-A-2472Z	2' x 6'	Fire w/z-clip lip	33 lbs	\$209 each
JWCF-A-2472ZZ	2' x 6'	Fire w/z-clip top & bottom	33 lbs	\$219 each

WallGUARD™ Fire/Impact

FR 1Y ★

Item	Size	Description	Weight	Price
JWCF-AI-2472	2' x 6'	Fire/Impact w/1" lip top & bottom	33 lbs	\$219 each
JWCF-AI-2472Z	2' x 6'	Fire/Impact w/z-clip lip	33 lbs	\$229 each
JWCF-AI-2472ZZ	2' x 6'	Fire/Impact w/z-clip top & bottom	33 lbs	\$239 each

Columns Corners I-Beams

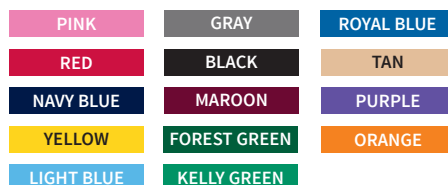

Dual Purpose Wall/Tumbling Mat



Serves as wall padding or as a tumbling mats.

- > 4' x 6' non-folding mat with 4 handle
- > 2" thick vinyl covered foam pad
- > 1½" wide hook-and-loop closures on all sides
- > See chart for colors (specify when ordering)

GMVH-1 \$345 each
FR 1Y ★

Hook-and-Loop Closure Wall Hanging Strip



For use with Dual Purpose Wall/Tumbling Mat (GMVH-1).

- > 2" wide aluminum strip easily mounts to any gymnasium wall
- > Pressure sensitive 1½" wide hook-and-loop closure securely bonds to aluminum strip for long lasting use
- > Only available in 4' sections

VMH-13 \$26 each 1Y ★



www.jaypro.com
T: 800-243-0533

F: 800-988-3363

Custom Graphics

Put your team logo or name on wall padding, pole padding, net tapes and more!



Custom Volleyball Net Tape

CVNT-1 Net Tape w/ Multi-Color Custom Graphics \$399 each

Volleyball Post Pad

PVL-39 Custom Lettering - Single Color (White) \$159 pad

JSG-VPP Custom Artwork - Multi-Color Call for Artwork Approval & Pricing

Rugby Goal Pad

JSG-RGP1 Custom Lettering - Single Color (White) Call for Artwork Approval & Pricing

JSG-RGP2 Custom Artwork - Multi-Color Call for Artwork Approval & Pricing

Football Post Pad

PVL-39 Custom Lettering - Single Color (White) \$159 pad

JSG-FPP Custom Artwork - Multi-Color Call for Artwork Approval & Pricing

Batting Cage Skirt

SKT-LOGO Custom Artwork - Multi-Color (8' wide max) \$299 each



by Jaypro Sports

Call 1-800-243-0533 to order today!



Backstop Wall Padding

JSG-BSP1 Custom Lettering - Single Color (White)

Call for Artwork Approval & Pricing

JSG-BSP2 Custom Artwork - Multi-Color

Call for Artwork Approval & Pricing

Field Wall Padding

JSG-FWP1 Custom Lettering - Single Color (White)

Call for Artwork Approval & Pricing

JSG-FWP2 Custom Artwork - Multi-Color

Call for Artwork Approval & Pricing

Basketball Pole Padding

JSG-BPP1 Custom Lettering - Single Color (White)

Call for Artwork Approval & Pricing

JSG-BPP2 Custom Artwork - Multi-Color

Call for Artwork Approval & Pricing

Gymnasium Wall Padding

JSG-GWP1 Custom Lettering - Single Color (White)

Call for Artwork Approval & Pricing

JSG-GWP2 Custom Artwork - Multi-Color

Call for Artwork Approval & Pricing



Portable FieldPro™ Net System Package

- > Dimensions: 60'L x 12'H
- > 4 black powder coated poles
- > 4 bases with vinyl covers and (16) 5 gallon jugs
- > 1¾" knotted nylon net
- > Hardware included

PFN-1260PKG

567 lbs

\$3,295 package



FIELDPRO™ NET SYSTEM a jaypro sports product

Portable FieldPro™ Net System

Ideal where in-ground net systems are not appropriate.

- > 12' tall net system
- > 2¾" dia aluminum pole on tip & roll base for easy transport
- > Base has (4) 5 gallon jugs (filled in the field) to weight it down
- > (2) 10" dia no-flat tires
- > Cable clamps and sliding rings for easy net assembly
- > Corrosion-resistant hardware included
- > Optional vinyl base covers sold separately
- > Typical pole spacing is 18' apart (should not exceed 20')
- > Pole can be powder coated black (specify when ordering)
- > Can be used inside as a space divider
- > Sold per base dependent on overall length needed (specify when ordering)
- > Call for pricing and details



Configure a Portable Net System

Follow steps 1 through 3 to create a unique model number in the boxes below.

MODEL # : — X

STEP 1: Select Net (enter net letter in box "1")

- A** #36 knotted multi-sport UV treated nylon net with 1¾" sq mesh and 1/4" rope border
- C** HTPP knotless UV treated net with 1¾" sq mesh and 1/4" rope border

STEP 2: Identify Length of System (enter numerical length in box "2")

Determine the length of the net in feet (i.e. 180). Keep in mind typical pole spacing is 18' apart and should not exceed 20'.

STEP 3: Call 1-800-243-0533 to provide your unique model number for details and pricing.



Optional Feature

Consider the following optional features when speaking with us about your Portable FieldPro™ Net System.

- PFN-BCVR** Portable net system base cover (standard color is red). See chart on page 13 for vinyl colors (specify preferred color when ordering).
2 lbs \$49 each





FieldPro™ Multi-Sport Net System

Stop wasting time chasing missed shots or errant passes during practice and games. Ensure the safety of athletes, coaches and spectators. This ball stop net system is ideal for lacrosse, field hockey and other field sports.

- > Designed to fit behind lacrosse and field hockey goals
- > (4) 4" OD heavy-walled aluminum uprights with ground sleeves and covers
- > #36 knotted UV treated black nylon net with 1¾" sq mesh and 1/4" rope border
- > Pulley system to raise/lower net included
- > Corrosion resistant hardware included
- > Dimensions: 65'W x 15'H

FNMB-65

\$2,350 each

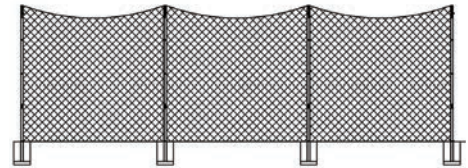

FieldPro™ Football Net System

Ideal for keeping field goals and extra point kicks inside the field.

- > 30' or 40' height options
- > 40' wide net easily raises and lowers with a rope and marine style swivel pulley system with integrated ball bearings
- > #36 knotted black nylon net with 3½" sq mesh and 1/4" rope border
- > 6½" dia aluminum poles (powder coated black if requested)
- > Ground sleeves and hardware included

FNFB-30

40'W x 30'H

530 lbs

\$4,295 each



FNFB-40

40'W x 40'H

762 lbs

\$6,695 each

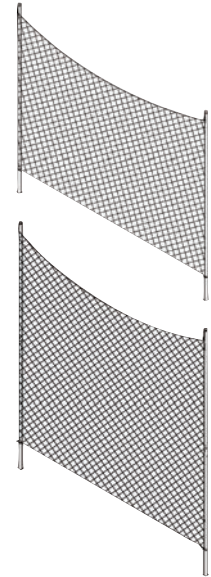

FieldPro™ Soccer Net System

Stop wasting time chasing missed shots or errant passes during practice and games. Ensure the safety of athletes, coaches and spectators.

- > Designed to fit behind soccer goals
- > (4) 4" OD heavy-walled aluminum uprights with ground sleeves and covers
- > #36 knotted black nylon net with 3½" sq mesh and 1/4" rope border
- > Pulley system to raise/lower net included
- > Corrosion resistant hardware included
- > Dimensions: 65'W x 20'H

FNSB-65 250 lbs \$2,250 each

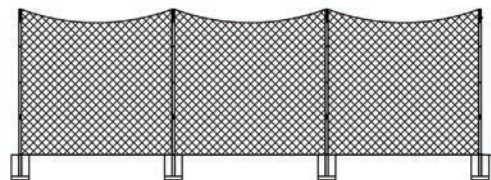

In-Ground FieldPro™ Net Systems



Perimeter Net Systems for All Turf Fields

In today's congested sports complexes with multi-use fields in close proximity to each other, keeping balls within the confines of the field is important. Stop wasting time during practices and games chasing missed shots or errant passes. Ensure the safety of athletes, coaches, and spectators alike on adjacent fields and tracks. FieldPro™ Net Systems by Jaypro Sports offer ultimate design flexibility to suit all perimeter netting needs.



Five Different Heights and Pole Styles

10' Straight Pole with multi-sport net is ideal for use as a Lacrosse or Field Hockey backstop net. The net is clipped at the top and bottom of each pole for easy removal.

15', 20' and 30' Straight Pole comes with an easy to use hoist system allowing quick and easy lowering or removal of the net after the game, season or before a big storm. Reinstalling the net is a snap - all from ground level with no need for a ladder.

20' Offset Pole provides 3' of offset which is ideal for use around the perimeter of soccer and baseball/softball fields. It's also an added measure of safety from ricocheting balls.



Basic Features & Recommendations

- > Pulley system to raise/lower net (excluding 10' poles)
- > Ground sleeves and caps allow for complete system removal (optional but recommended)
- > Corrosion-resistant hardware included
- > Optional vinyl base covers sold separately
- > Pole can be powder coated black (specify when ordering)
- > Typical pole spacing is 18' apart and should not exceed 20'
- > It is recommended net systems are set back at least 25' from the playing field
- > Call for pricing and details



www.jaypro.com
T: 800-243-0533 F: 800-988-3363

T: 800-243-0533
F: 800-988-3363

FIELDPRO™

NET SYSTEM

a **jaypro sports** product

Configure an In-Ground Net System

Follow steps 1 through 4 to create a unique model number in the boxes below.

MODEL # : – X
1 2 3

STEP 1:

Select Pole (enter pole number in box "1")

- FN-10** 10' tall straight 2¾" OD heavy-walled aluminum pole
- FN-15** 15' tall straight 4" OD heavy-walled aluminum pole
- FNS-20** 20' tall straight 4" OD heavy-walled aluminum pole
- FNO-20** 20' tall offset 4" OD heavy-walled aluminum pole
- FNS-30** 30' tall straight 6⅝" OD heavy-walled aluminum pole

STEP 3:

Identify Length of System (enter numerical length in box "3")

Determine the length of the net in feet (i.e. 180)
 Keep in mind typical pole spacing is 18' apart and should not exceed 20'.

STEP 2:

Select Net (enter net letter in box "2")

- A** #36 knotted multi-sport UV treated nylon net with 1¾" sq mesh and 1/4" rope border
- B** #36 knotted soccer/football UV treated nylon net with 3½" sq mesh and 1/4" rope border
- C** HTPP knotless UV treated net with 1¾" sq mesh and 1/4" rope border
- D** HTPP knotless UV treated net with 4" sq mesh and 1/4" rope border

STEP 4:

Call 1-800-243-0533 to provide your unique model number for details and pricing.

Optional Feature

- > Poles can be powder coated black (specify when ordering).
- > Ground Sleeves sold separately.



www.jaypro.com
 T: 800-243-0533

F: 800-988-3363

Custom Net FieldPro™ Net Systems

Jaypro Sports can solve any netting problem. From indoor and outdoor requirements, to pole and structure support, we have the solution for your athletic field or facility.

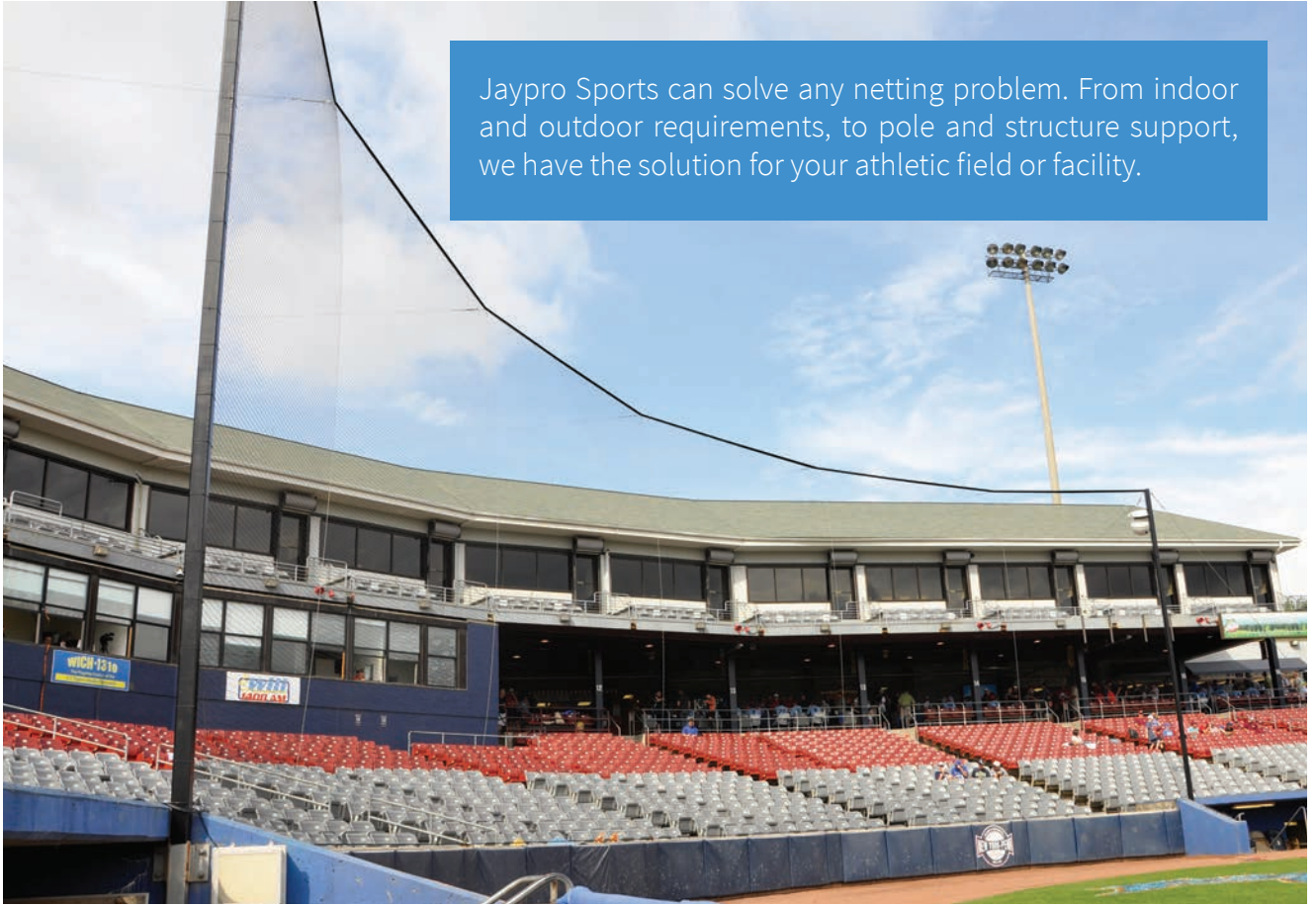



FieldPro™ Discus Cage



FieldPro™ Discus Cage

Ideal for high schools.

- > Meets all NFHS rules and regulations
- > Designed to accommodate a 34.92 degree throwing sector
- > (6) 4" OD heavy-walled aluminum poles
- > 14'6" tall poles have 24" offset to minimize ricochet
- > Heavy-duty weather treated black nylon net with 17/8" mesh
- > Ground anchors hold net in place
- > Pulley hoisting system allows for easy net removal and set-up
- > Ground sleeves and covers for complete system removal during off season, sold separately
- > Optional 7' tall perimeter barrier net (DCHS-BN) for added protection sold separately
- > Net Dimensions: 54'L x 14'H

FR 3Y 1Y ★

DCHS-35 Discus Cage w/Net No Sleeves \$2725

DCHS-35NET Replacement Cage Net 14'H x 55'L \$479

DCHS-6S Replacement Ground Sleeves Set of 6 \$479

DCHS-35BN (DCHS-35) plus Barrier Net No Sleeves \$3095

DCHS-BN Replacement Barrier Net 7'H x 63'L \$435



www.jaypro.com
T: 800-243-0533

F: 800-988-3363

ToteMaster™ Ball Storage Carts

TOTEMASTER™ a **jaypro sports** product

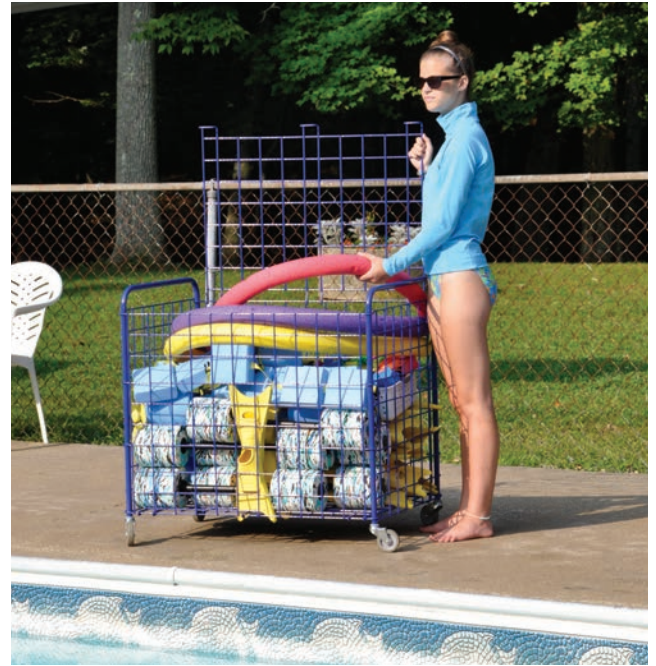

The Original ToteMaster™

All-purpose carrier with large holding capacity for all types of equipment.

- > Holds 20-25 balls
- > Indoor or outdoor use
- > 3/16" all-welded steel wire with 3" sq mesh
- > Lockable hinged top (lock not included)
- > 4 heavy-duty swivel wheels
- > No tools required
- > Dimensions: 2'W x 3'L x 3'H



TE-2

45 lbs

\$225 each



3Y

Replacement Casters and Inserts

- > 4 swivel wheels and inserts

TE-2HK

\$32 set





Mini ToteMaster™

- > Indoor or outdoor all-purpose carrier
- > 3/16" all-welded steel wire with 3" sq mesh
- > Lockable hinged top (lock not included)
- > 4 heavy-duty swivel wheels
- > No tools required
- > Dimensions: 21"W x 21"L x 30"H

TE-30 25 lbs \$155 each  3Y



ToteMaster™ Plus

- > 3/16" all-welded steel wire with 3" sq mesh
- > Lockable dual tops (lock not included)
- > 4 large heavy-duty swivel wheels
- > Divider to separate equipment
- > Dimensions: 2'W x 5'L x 3'H



TE-60 70 lbs \$315 each  3Y



ToteMaster™ All Terrain

- > Holds 20-25 balls
- > Indoor or outdoor all-purpose carrier
- > 3/16" all-welded steel wire with 3" sq mesh
- > Lockable hinged top (lock not included)
- > 2 heavy-duty swivel and (2) 12" fixed all terrain wheels
- > Dimensions: 2'W x 3'L x 3'H

AT-5 63 lbs \$299 each  3Y



ToteMaster™ Field

- > Indoor or outdoor all-purpose carrier
- > 3/16" all-welded steel wire with 3" sq mesh
- > Lockable hinged top (lock not included)
- > 6" semi-pneumatic front swivel casters
- > 20" semi-pneumatic rear all terrain wheels
- > 10" ground clearance
- > Dimensions: 25"W x 51"L x 48"H
- > Basket Size: 23"W x 41"L x 27"H

AT-10 65 lbs \$395 each  3Y



www.jaypro.com
T: 800-243-0533

F: 800-988-3363

ToteMaster™ Ball Storage Carts



**ToteMaster™
Open Top**

- > Indoor all-purpose carrier
- > 2 full-size open top storage baskets with 4" x 3" wire mesh
- > (2) 360° rotating hangers for jump rope and hoop storage
- > 4 swivel wheels
- > Optional side shelf (TE-PESHELF) sold separately
- > Dimensions: 26"W x 48"L x 54"H

TE-PE01 48 lbs \$249 each
TE-PESHELF 5 lbs \$16 each



**ToteMaster™
Deluxe
Open Top**

- > Indoor or outdoor all-purpose carrier
- > 2 full-size open top storage baskets with 4" x 3" wire mesh
- > (4) 360° rotating hangers for jump rope and hoop storage
- > 2 heavy-duty swivel and 2 fixed all terrain wheels
- > Side shelf storage
- > Additional side shelves (TE-PESHELF) sold separately
- > Dimensions: 26"W x 48"L x 54"H

TE-PE02 56 lbs \$299 each



Atlas Series™ Ball Storage Carts



**Atlas
Series™
Ball Locker**

- > Highly durable
- > Stores up to 28 basketballs or 35 volleyballs
- > Strong enough to store medicine balls
- > 1" thick-walled square steel tubing frame
- > Lockable hinged top (lock not included)
- > Heavy-duty non-marking swivel wheels
- > Dimensions: 24"W x 47"L x 37"H

BBABL-1 63 lbs \$359 each



**Atlas
Series™
Ball Locker
& Hamper**

- > Indoor or outdoor use
- > Stores up to 28 basketballs
- > 1" round steel tubing frame
- > Lockable hinged top (lock not included)
- > 2 heavy-duty swivel and (2) 8" fixed all terrain wheels
- > Mesh hamper liner included for storage of towels or uniforms
- > Dimensions: 24"W x 45"L x 35"H

BBABL-2 70 lbs \$379 each



**Atlas
Series™
Ball Cart**

- > Multi-level rack stores up to 15 balls
- > 1" thick-walled square steel tubing frame
- > 4 heavy-duty non-marking swivel wheels
- > Dimensions: 18"W x 51½"L x 36"H

BBABC-1 31 lbs \$239 each



**Atlas
Series™
Double
Ball Cart**

- > Multi-level rack stores up to 30 balls
- > 1" thick-walled square steel tubing frame
- > 4 heavy-duty non-marking swivel wheels
- > Dimensions: 24"W x 51½"L x 36"H

BBABC-2 52 lbs \$339 each



StackMaster™ Ball Storage Racks

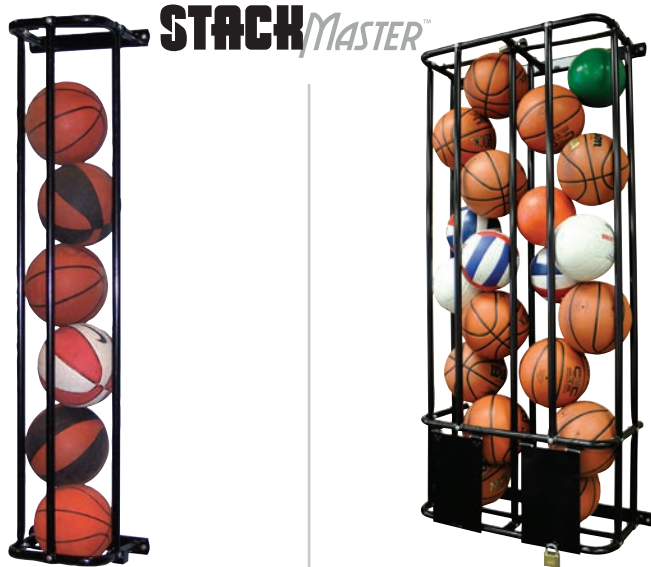

StackMaster™ Single Wall Rack

- > Stores up to 6 basketballs
- > 1" steel tubing frame
- > Lockable top/bottom bars (lock not included)
- > Mounting hardware not included
- > Dimensions: 15"W x 66"H x 12"D

PE-140

18 lbs \$109 each 3Y

StackMaster™ Double Wall Rack

- > Stores up to 16 basketballs or 30 volleyballs
- > 1" steel tubing frame
- > Lockable top/bottom bars (lock not included)
- > Mounting hardware not included
- > Dimensions: 37"W x 66"H x 12"D

PE-240

49 lbs \$179 each 3Y

Deluxe Training Ball Rack

Ideal for shooting competitions and free throw practice.

- > Highly durable
- > 1" OD tubing on rails and ends
- > Holds 19 regulation basketballs
- > Feeds top 7 balls to shooter
- > Heavy-duty non-marking swivel wheels (front 2 lockable)
- > Dimensions: 18"W x 61"L x 44"H

DTBR-19

40 lbs \$199 each 3Y

Ball Carriers

Deluxe 12 Ball Carrier

Ideal for basketballs, volleyballs and medicine balls.

- > Highly durable
- > All welded 1" OD steel frame and crossbars
- > Holds up to 12 basketballs
- > 4 heavy-duty swivel wheels
- > Dimensions: 22"W x 39"L x 36"H

BBC-12RB	ROYAL BLUE	27 lbs	\$149 each
BBC-12BK	BLACK	27 lbs	\$149 each
BBC-12RD	RED	27 lbs	\$149 each

3Y

Deluxe 18 Ball Carrier

Ideal for basketballs, volleyballs and medicine balls.

- > Highly durable
- > All welded 1" OD steel frame and crossbars
- > Holds up to 18 basketballs
- > 4 heavy-duty swivel wheels
- > Dimensions: 22"W x 60"L x 36"H

BBC-18RB	ROYAL BLUE	41 lbs	\$172 each
BBC-18BK	BLACK	41 lbs	\$172 each
BBC-18RD	RED	41 lbs	\$172 each

3Y



Holds
Basketballs
Medicine Balls
Volleyballs



www.jaypro.com
T: 800-243-0533

F: 800-988-3363

Player Benches

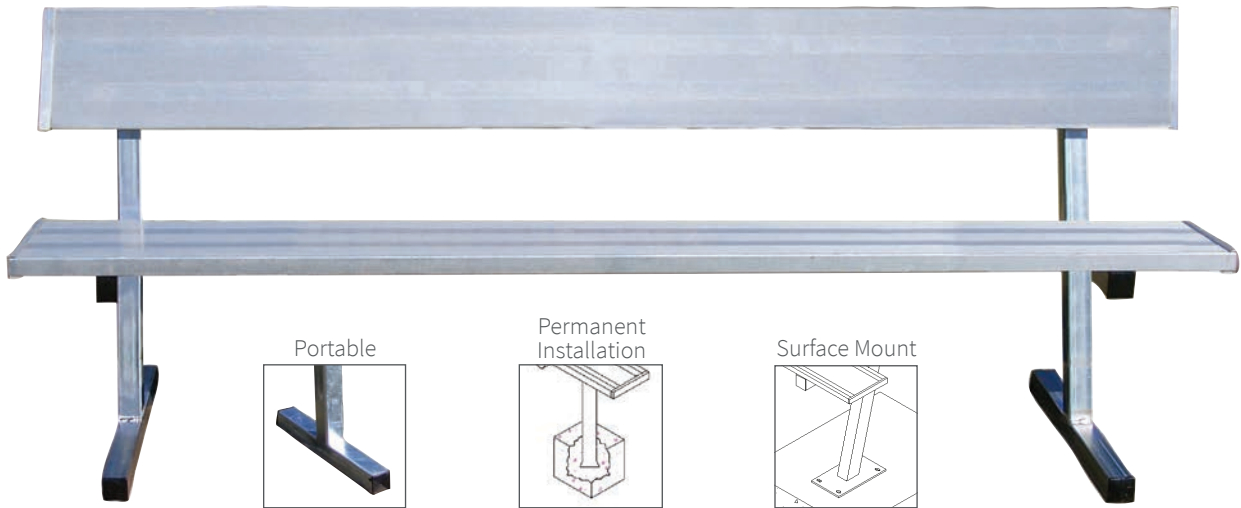

Player Bench

Ideal for athletic fields, public parks and sport complexes.

- > Rust-resistant and stable
- > Aluminum 10" non-skid seat planks and 2" x 2" heavy-duty galvanized steel legs
- > Available with or without seat back
- > Portable, permanent installation, or surface mount choices

- > Floor protection kit (PSS-4FT) for indoor use sold separately
- > Natural finish or powder coated colors (specify plank and leg colors when ordering)
- > Natural finish benches ship within 48 hours
- > All but 7½' length ships by truck

FR 3Y

Natural Finish - With Seat Back

Length	Portable	Permanent	Surface	Weight	Price
7½'	PB-80	PB-80PI	PB-80SM	60 lbs	\$339
15'	PB-20	PB-20PI	PB-20SM	100 lbs	\$529
21'	PB-10	PB-10PI	PB-10SM	135 lbs	\$689
27'	PB-90	PB-90PI	PB-90SM	175 lbs	\$769

Natural Finish - Without Seat Back

Portable	Permanent	Surface	Weight	Price
PB-75	PB-75PI	PB-75SM	33 lbs	\$239
PB-15	PB-15PI	PB-15SM	57 lbs	\$319
PB-5	PB-5PI	PB-5SM	79 lbs	\$449
PB-95	PB-95PI	PB-95SM	101 lbs	\$519



FR 3Y

Powder Coated - With Seat Back

Length	Portable	Permanent	Surface	Weight	Price
7½'	PB-80PC	PB-80PIPC	PB-80SMPC	60 lbs	\$449
15'	PB-20PC	PB-20PIPC	PB-20SMPC	100 lbs	\$679
21'	PB-10PC	PB-10PIPC	PB-10SMPC	135 lbs	\$809
27'	PB-90PC	PB-90PIPC	PB-90SMPC	175 lbs	\$909

Powder Coated - Without Seat Back

Portable	Permanent	Surface	Weight	Price
PB-75PC	PB-75PIPC	PB-75SMPC	33 lbs	\$309
PB-15PC	PB-15PIPC	PB-15SMPC	57 lbs	\$389
PB-5PC	PB-5PIPC	PB-5SMPC	79 lbs	\$519
PB-95PC	PB-95PIPC	PB-95SMPC	101 lbs	\$619

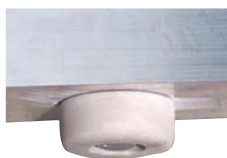

Floor Protection Kit

- > Optional floor protector kit prevents floor marking
- > 4 rubber feet with self-threading screws (2 per leg)

PSS-4FT 2 lbs \$30 kit 3Y



See page 131 for our 4' Bench (PB40PC)



Pro Player Bench

- > Rust-resistant and stable
- > Larger aluminum 12" non-skid seat plank and 2" x 2" heavy-duty galvanized steel legs
- > Seat sits 3" higher than standard benches at 20" and is contoured for comfort
- > Improved strength with additional leg supports and cross bracing
- > Natural finish or powder coated colors (specify plank and leg colors when ordering)



FR 3Y

Natural Finish

Length	Item #	Weight	Price
15'	PB20-PRO	124 lbs	\$999
21'	PB10-PRO	161 lbs	\$1,199

Powder Coated

Item #	Price
PB20-PROPC	\$1,149
PB10-PROPC	\$1,399



Player Bench with Shelf

- > Rust-resistant and stable
- > 20" wide shelf can be used for helmets, gloves, water and other items
- > Aluminum 10" non-skid seat planks and 2" x 2" heavy-duty galvanized steel legs
- > Natural finish or powder coated colors (specify plank and leg colors when ordering)
- > Natural finish benches ship within 48 hours

FR 3Y

Natural Finish

Length	Item #	Weight	Price
7½'	PBS-80	95 lbs	\$539
15'	PBS-20	130 lbs	\$759
21'	PBS-10	185 lbs	\$999
27'	PBS-90	200 lbs	\$1,599

Powder Coated

Item #	Price
PBS-80PC	\$629
PBS-20PC	\$949
PBS-10PC	\$1,339
PBS-90PC	\$1,949

Wall-Mounted Player Bench

- > Rust-resistant and stable
- > Aluminum 10" non-skid seat planks and corrosion-resistant understructure
- > Understructure mounted to wall with stainless steel hardware (provided by local installer)
- > Natural finish or powder coated colors (specify plank and understructure colors when ordering)

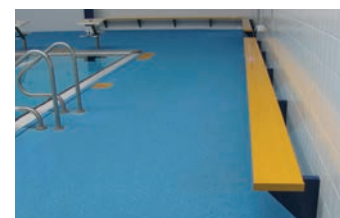

FR 3Y

Natural Finish

Length	Item #	Weight	Price
7½'	PBW-75	20 lbs	\$299
15'	PBW-15	40 lbs	\$359
21'	PBW-5	60 lbs	\$469
27'	PBW-95	80 lbs	\$530

Powder Coated

Item #	Price
PBW-75PC	\$349
PBW-15PC	\$439
PBW-5PC	\$569
PBW-95PC	\$679



Scorer Table

- > Rust-resistant and stable
- > Aluminum 10" non-skid seat planks and 2" x 2" heavy-duty galvanized steel legs
- > Natural finish or powder coated colors (specify plank and leg colors when ordering)
- > Tabletop: 19"W x 7½'L

3Y

Natural Finish

Length	Item #	Weight	Price
7½'	ST75	90 lbs	\$489

Powder Coated

Item #	Price
ST75PC	\$579



www.jaypro.com
T: 800-243-0533

F: 800-988-3363

Tip & Roll Bleachers



BLCH-4TRG with Standard Foot Planks

Tip & Roll Standard Bleacher

- > Lightweight and stable with single foot planks
- > All aluminum 10" non-skid seat planks and understructure
- > Tips for easy mobility and storage
- > Transition foot prevents floor marking
- > (4) 4" non-marring swivel casters
- > 2, 3 and 4 row configuration
- > 4 row bleachers do not exceed 30" in height
- > Guard rails may not be needed (check your local codes)
- > Natural finish or powder coated colors (specify plank and understructure colors when ordering)
- > Also available as preferred bleachers (double foot planks on all rows)

FR 3Y

Natural Finish

Rows	Length	Seats	Item #	Weight	Price
2	7½'	10	BLCH-275TRG	75 lbs	\$749
	15'	20	BLCH-2TRG	135 lbs	\$1,075
	21'	30	BLCH-221TRG	180 lbs	\$1,399
	27'	38	BLCH-227TRG	225 lbs	\$1,749
3	7½'	15	BLCH-375TRG	118 lbs	\$999
	15'	30	BLCH-3TRG	210 lbs	\$1,375
	21'	42	BLCH-321TRG	270 lbs	\$1,749
	27'	54	BLCH-327TRG	330 lbs	\$2,299
4	7½'	20	BLCH-475TRG	155 lbs	\$1,299
	15'	40	BLCH-4TRG	310 lbs	\$1,975
	21'	52	BLCH-421TRG	415 lbs	\$2,299
	27'	70	BLCH-427TRG	520 lbs	\$2,699

Powder Coated

Rows	Length	Seats	Item #	Weight	Price
2	7½'	10	BLCH-275TRGPC	75 lbs	\$829
	15'	20	BLCH-2TRGPC	135 lbs	\$1,175
	21'	30	BLCH-221TRGPC	180 lbs	\$1,549
	27'	38	BLCH-227TRGPC	225 lbs	\$1,999
3	7½'	15	BLCH-375TRGPC	118 lbs	\$1,149
	15'	30	BLCH-3TRGPC	210 lbs	\$1,525
	21'	42	BLCH-321TRGPC	270 lbs	\$1,949
	27'	54	BLCH-327TRGPC	330 lbs	\$2,499
4	7½'	20	BLCH-475TRGPC	155 lbs	\$1,449
	15'	40	BLCH-4TRGPC	310 lbs	\$2,075
	21'	52	BLCH-421TRGPC	415 lbs	\$2,549
	27'	70	BLCH-427TRGPC	520 lbs	\$3,199



- PINK
- RED
- NAVY BLUE
- YELLOW
- GOLD
- GRAY
- BLACK
- MAROON
- DARK GREEN
- KELLY GREEN
- ROYAL BLUE
- WHITE
- ORANGE





BLDP-4TRGPC with Preferred Foot Planks

Tip & Roll Preferred Bleacher

- > Lightweight and stable with double foot planks
- > All aluminum 10" non-skid seat planks and understructure
- > Transition foot prevents floor marking
- > (4) 4" non-marring swivel casters
- > 2, 3 and 4 row configuration
- > 4 row bleachers do not exceed 30" in height
- > Guard rails may not be needed (check your local codes)
- > Natural finish or powder coated colors (specify plank and understructure colors when ordering)
- > Also available as standard bleachers (single foot planks on all rows)

FR 3Y

Natural Finish

Rows	Length	Seats	Item #	Weight	Price
2	7½'	10	BLDP-275TRG	100 lbs	\$819
	15'	20	BLDP-2TRG	170 lbs	\$1,199
	21'	30	BLDP-221TRG	230 lbs	\$1,619
	27'	38	BLDP-227TRG	290 lbs	\$1,999
3	7½'	15	BLDP-375TRG	150 lbs	\$1,149
	15'	30	BLDP-3TRG	265 lbs	\$1,599
	21'	42	BLDP-321TRG	360 lbs	\$2,049
	27'	54	BLDP-327TRG	455 lbs	\$2,399
4	7½'	20	BLDP-475TRG	210 lbs	\$1,599
	15'	40	BLDP-4TRG	405 lbs	\$2,349
	21'	52	BLDP-421TRG	540 lbs	\$2,799
	27'	70	BLDP-427TRG	675 lbs	\$3,249

Powder Coated

Rows	Length	Seats	Item #	Weight	Price
2	7½'	10	BLDP-275TRGPC	100 lbs	\$849
	15'	20	BLDP-2TRGPC	170 lbs	\$1,299
	21'	30	BLDP-221TRGPC	230 lbs	\$1,799
	27'	38	BLDP-227TRGPC	290 lbs	\$2,199
3	7½'	15	BLDP-375TRGPC	150 lbs	\$1,199
	15'	30	BLDP-3TRGPC	265 lbs	\$1,749
	21'	42	BLDP-321TRGPC	360 lbs	\$2,249
	27'	54	BLDP-327TRGPC	455 lbs	\$2,799
4	7½'	20	BLDP-475TRGPC	210 lbs	\$1,749
	15'	40	BLDP-4TRGPC	405 lbs	\$2,399
	21'	52	BLDP-421TRGPC	540 lbs	\$3,099
	27'	70	BLDP-427TRGPC	675 lbs	\$3,649



- PINK
- RED
- NAVY BLUE
- YELLOW
- GOLD
- GRAY
- BLACK
- MAROON
- DARK GREEN
- KELLY GREEN
- ROYAL BLUE
- WHITE
- ORANGE



www.jaypro.com
T: 800-243-0533

F: 800-988-3363

Aluminum Outdoor Bleachers



BLCH-4AL with Standard Foot Planks



All Aluminum Standard Bleacher

- > Lightweight and stable with single foot planks
- > All aluminum 10" non-skid seat planks and understructure
- > 3 and 4 row configuration
- > 4 row bleachers do not exceed 30" in height
- > Guard rails may not be needed (check your local codes)
- > Natural finish or powder coated colors (specify plank and understructure colors when ordering)
- > Also available as preferred bleachers (double foot planks on all rows)

FR 3Y

Natural Finish

Rows	Length	Seats	Item #	Weight	Price
3	15'	30	BLCH-3AL	240 lbs	\$1,325
	21'	42	BLCH-321AL	340 lbs	\$1,649
	27'	54	BLCH-327AL	440 lbs	\$2,199
4	15'	40	BLCH-4AL	320 lbs	\$1,875
	21'	52	BLCH-421AL	440 lbs	\$2,249
	27'	70	BLCH-427AL	560 lbs	\$2,649

Powder Coated

Rows	Length	Seats	Item #	Weight	Price
3	15'	30	BLCH-3ALPC	240 lbs	\$1,425
	21'	42	BLCH-321ALPC	340 lbs	\$1,899
	27'	54	BLCH-327ALPC	440 lbs	\$2,449
4	15'	40	BLCH-4ALPC	320 lbs	\$2,025
	21'	52	BLCH-421ALPC	440 lbs	\$2,499
	27'	70	BLCH-427ALPC	560 lbs	\$2,999



- PINK
- RED
- NAVY BLUE
- YELLOW
- GOLD
- GRAY
- BLACK
- MAROON
- DARK GREEN
- KELLY GREEN
- ROYAL BLUE
- WHITE
- ORANGE

Indoor Conversion Kit

Ideal for converting outdoor bleachers to indoor bleachers.

- > Protects indoor floor surfaces
- > 12 rubber feet attach to bottom of bleacher legs
- > For 2, 3 and 4 row bleachers at lengths of 7½', 15', 21' and 27'

- > 7½' bleacher requires 1 kit
- > 15' and 21' bleachers require 2 kits
- > 27' bleacher require 3 kits

BLCHICK34 4 lbs \$49 set **3Y**



www.jaypro.com
T: 800-243-0533 F: 800-988-3363

T: 800-243-0533
F: 800-988-3363



BLDP-4ALPC with Preferred Foot Planks

All Aluminum Preferred Bleacher

- > Lightweight and stable with double foot planks
- > All aluminum 10" non-skid seat planks and understructure
- > 3 and 4 row configuration
- > 4 row bleachers do not exceed 30" in height
- > Guard rails may not be needed (check your local codes)
- > Natural finish or powder coated colors (specify plank and understructure colors when ordering)
- > Also available as standard bleachers (single foot planks on all rows)

FR 3Y

Natural Finish

Rows	Length	Seats	Item #	Weight	Price
3	15'	30	BLDP-3AL	290 lbs	\$1,499
	21'	42	BLDP-321AL	415 lbs	\$1,849
	27'	54	BLDP-327AL	540 lbs	\$2,299
4	15'	40	BLDP-4AL	395 lbs	\$2,249
	21'	52	BLDP-421AL	550 lbs	\$2,749
	27'	70	BLDP-427AL	705 lbs	\$3,199

Powder Coated

Rows	Length	Seats	Item #	Weight	Price
3	15'	30	BLDP-3ALPC	290 lbs	\$1,729
	21'	42	BLDP-321ALPC	415 lbs	\$2,199
	27'	54	BLDP-327ALPC	540 lbs	\$2,749
4	15'	40	BLDP-4ALPC	395 lbs	\$2,449
	21'	52	BLDP-421ALPC	550 lbs	\$3,049
	27'	70	BLDP-427ALPC	705 lbs	\$3,399



- PINK
- RED
- NAVY BLUE
- YELLOW
- GOLD
- GRAY
- BLACK
- MAROON
- DARK GREEN
- KELLY GREEN
- ROYAL BLUE
- WHITE
- ORANGE

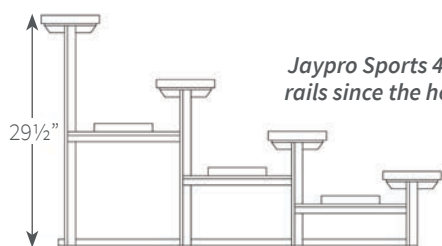

Jaypro Sports 4 row bleachers may not require guard rails since the height is less than 30" from the ground. Check your local code requirements.

169 Possible Color Combinations



www.jaypro.com
T: 800-243-0533

F: 800-988-3363

Back-to-Back Bleachers



BTBB-321 with Standard Foot Planks

Back-to-Back Standard Bleacher

Ideal for viewing activities from both sides and between adjoining fields or indoor courts.

- > Lightweight and stable with single foot planks
- > All aluminum 10" non-skid seat planks and understructure
- > Indoor conversion kit (BLCHICK34) sold separately
- > Natural finish or powder coated colors (specify plank and understructure colors when ordering)
- > Also available as preferred bleachers (double foot planks on all rows)

FR 3Y

Natural Finish

Rows	Length	Seats	Item #	Weight	Price
3	7½'	25	BTBB-375	299 lbs	\$1,879
	15'	50	BTBB-3	540 lbs	\$2,319
	21'	72	BTBB-321	668 lbs	\$2,879

Powder Coated

Rows	Length	Seats	Item #	Weight	Price
3	7½'	25	BTBB-375PC	299 lbs	\$2,049
	15'	50	BTBB-3PC	540 lbs	\$2,489
	21'	72	BTBB-321PC	668 lbs	\$3,099

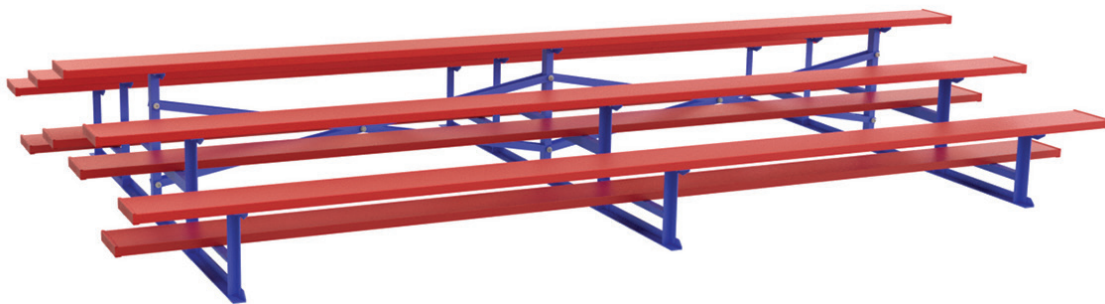

- PINK
- RED
- NAVY BLUE
- YELLOW
- GOLD
- GRAY
- BLACK
- MAROON
- DARK GREEN
- KELLY GREEN
- ROYAL BLUE
- WHITE
- ORANGE



Indoor Conversion Kit

Ideal for converting outdoor bleachers to indoor bleachers.

- > Protects indoor floor surfaces
- > 12 rubber feet attach to bottom of bleacher legs
- > For 2, 3 and 4 row bleachers at lengths of 7½', 15', 21' and 27'
- > 7½' bleacher requires 1 kit
- > 15' and 21' bleachers require 2 kits
- > 27' bleacher require 3 kits

BLCHICK34 4 lbs \$49 set **3Y**



www.jaypro.com
T: 800-243-0533 F: 800-988-3363

T: 800-243-0533
F: 800-988-3363



BTDP-321 with Preferred Foot Planks

Back-to-Back Preferred Bleacher

- > Lightweight and stable with single foot planks
- > All aluminum 10" non-skid seat planks and understructure
- > Indoor conversion kit (BLCHICK34) sold separately
- > Natural finish or powder coated colors (specify plank and understructure colors when ordering)
- > Also available as standard bleachers (single foot planks on all rows)

FR 3Y

Aluminum, Preferred, Natural Finish

Rows	Length	Seats	Item #	Weight	Price
3	7½'	25	BTDP-375	363 lbs	\$2,099
	15'	50	BTDP-3	670 lbs	\$2,579
	21'	72	BTDP-321	903 lbs	\$3,199

Aluminum, Preferred, Powder Coated

Rows	Length	Seats	Item #	Weight	Price
3	7½'	25	BTDP-375PC	363 lbs	\$2,399
	15'	50	BTDP-3PC	670 lbs	\$2,899
	21'	72	BTDP-321PC	903 lbs	\$3,549



169 Possible
Color Combinations

- PINK
- RED
- NAVY BLUE
- YELLOW
- GOLD
- GRAY
- BLACK
- MAROON
- DARK GREEN
- KELLY GREEN
- ROYAL BLUE
- WHITE
- ORANGE



www.jaypro.com
T: 800-243-0533

F: 800-988-3363

Aluminum & Steel Bleachers



- PINK
- RED
- NAVY BLUE
- YELLOW
- GOLD
- GRAY
- BLACK
- MAROON
- DARK GREEN
- KELLY GREEN
- ROYAL BLUE
- WHITE
- ORANGE

Outdoor Standard Bleacher

- > Lightweight and stable
- > Aluminum 10" non-skid seat planks
- > Strong galvanized steel understructure made of 3/16" x 1 1/2" angled framing
- > Additional stability with dual braces and rear stabilizing bar

- > 3 and 4 row configuration
- > 4 row bleachers do not exceed 30" in height
- > Guard rails may not be needed (check your local codes)
- > Natural finish or powder coated colors (specify plank and understructure colors when ordering)

FR 3Y

Natural Finish

Rows	Length	Seats	Item #	Weight	Price
3	15'	30	BLCH-3	305 lbs	\$1,299
	21'	42	BLCH-321	425 lbs	\$1,649
	27'	54	BLCH-327	545 lbs	\$2,149
4	15'	40	BLCH-4	390 lbs	\$1,849
	21'	52	BLCH-421	520 lbs	\$2,299
	27'	70	BLCH-427	650 lbs	\$2,649

Powder Coated

Rows	Length	Seats	Item #	Weight	Price
3	15'	30	BLCH-3PC	305 lbs	\$1,449
	21'	42	BLCH-321PC	425 lbs	\$1,899
	27'	54	BLCH-327PC	545 lbs	\$2,399
4	15'	40	BLCH-4PC	390 lbs	\$1,999
	21'	52	BLCH-421PC	520 lbs	\$2,499
	27'	70	BLCH-427PC	650 lbs	\$2,949



Bleacher and Bench Plank Pad

Ideal for creating comfortable bleacher seating for players and spectators.

- > Easy installation with straps that buckle under the plank
- > For bleachers at lengths of 7 1/2', 15' and 21'
- > 7 1/2' bleacher requires 1 pad
- > 15' bleachers require 2 pads
- > 21' bleacher require 3 pads
- > Specify pad color when ordering
- > Call for freight quote (extended lead time may apply)
- > Dimensions: 10"W x 7"L x 1 3/8"H

PLKPAD7 5 lbs \$135 each 1Y ★

DARK PURPLE	NAVY BLUE
RED	ROYAL BLUE
BURGUNDY	FOREST GREEN
KELLY GREEN	YELLOW
BLACK	ORANGE
WHITE	GRAY
ROYAL BLUE	GOLD
DARK GREEN	GRAY
KELLY GREEN	BLACK
ROYAL BLUE	BLACK



Bleacher Transport Kit

Ideal for moving bleachers from field to field.

- > (2) 4"W x 12"H heavy-duty wheels
- > Fits any angle framed 2, 3, 4 or 5 row bleachers at lengths of 15', 21' and 27'
- > Wheels and tongue easily remove when not in use or to use with other bleachers
- > Additional mounting bracket and axle receivers (BLCH-TMKIT) sold separately

BLCH-TOW4515	15'	\$795 each	3Y
BLCH-TOW4521	21' - 27'	\$895 each	3Y
BLCH-TMKIT	Mounting Kit	\$229 each	3Y



Enclosed Bleacher

- > Lightweight and stable
- > Aluminum 10" non-skid seat planks
- > Strong galvanized steel understructure made of 3/16" x 1 1/2" angled framing
- > Additional stability with dual braces and rear stabilizing bar
- > 5 and 10 row configuration

- > Risers and double foot planks added to bleachers over 30" high for increased safety
- > Available with vertical guard rails or chain-link enclosure
- > Aisle option includes 2" OD handrail in center of bleacher
- > Natural finish or powder coated colors (specify plank, understructure and guardrail colors when ordering)
- > Note: Powder coating not available on chain-link enclosures or 10 row bleachers



Natural Finish

Rows	Length	Seats	Enclosure	Item #	Weight	Price
5	15'	50	Guard Rail	BLCH-5GR	1,172 lbs	\$4,895
	15'	50	Chain Link	BLCH-5C	1,012 lbs	\$4,295
21'	62	62	Guard Rail	BLCH-521GR	1,452 lbs	\$5,495
	62	62	Chain Link	BLCH-521C	1,252 lbs	\$5,215
21'	58	58	Guard Rail w/Aisle	BLCH-521ASGR	1,500 lbs	\$7,995
27'	80	80	Guard Rail	BLCH-527GR	1,732 lbs	\$6,995
	80	80	Chain Link	BLCH-527C	1,492 lbs	\$5,995
10	15'	100	Guard Rail	BLCH-10GR	2,500 lbs	\$10,995
	21'	140	Guard Rail	BLCH-1021GR	2,700 lbs	\$13,995
	21'	114	Guard Rail w/Aisle	BLCH-1021ASGR	3,000 lbs	\$15,495
	27'	170	Guard Rail	BLCH-1027GR	3,464 lbs	\$16,995
27'	134	Guard Rail w/Aisle	BLCH-1027ASGR	3,700 lbs	\$17,995	

Powder Coated

Rows	Item #	Price
5	BLCH-5GRPC	\$5,399
	N/A	N/A
21'	BLCH-521GRPC	\$6,995
	N/A	N/A
21'	BLCH-521ASGRPC	\$8,295
	BLCH-527GRPC	\$7,449
10	N/A	N/A
	N/A	N/A
	N/A	N/A
	N/A	N/A

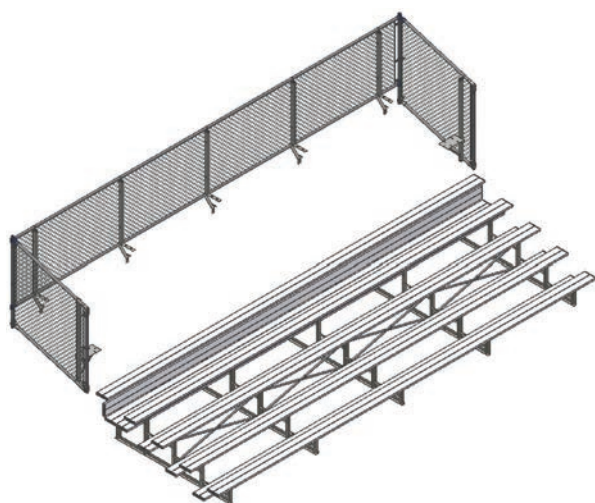

Universal Enclosure

Ideal for upgrading 5 row bleachers to comply with local safety codes.

- > Designed to enclose bleacher seating higher than 30"
- > Fits most bleacher brands
- > Bolts to 5 row bleachers at lengths of 15', 21' and 27'
- > Footboard and kickboard included
- > Attachment frame and hardware kit included

BLCH5CUE15 5 Row 15' Bleacher Enclosure
250 lbs \$2,295 each **FR** **3Y**

BLCH5CUE21 5 Row 21' Bleacher Enclosure
275 lbs \$2,895 each **FR** **3Y**

BLCH5CUE27 5 Row 27' Bleacher Enclosure
300 lbs \$3,695 each **FR** **3Y**



Tennis Posts



3" Club Tennis Posts

- > Available in 3" round or square posts
- > 11 gauge steel construction
- > Solid stainless steel internal worm gear winch with self-locking mechanism to prevent recoiling during winding
- > Removable winch handle
- > Welded lacing rods for net attachment included
- > Nets (TTN-3, TPL-5, CCPTN42) sold separately
- > Ground sleeves (RTPGS-3, STPGS-2) for semi-permanent installation sold separately

RTP-300	Round	47 lbs	\$325 pair	
STP-200	Square	58 lbs	\$325 pair	

Replacement Winch

RTP-300WH	Round Winch and Handle	4 lbs	\$89 each	
STP-200WH	Square Winch and Handle	4 lbs	\$89 each	

3" Ground Sleeves

RTPGS-3	Ground Sleeves (RTP-300)	24"L	12 lbs	\$105 pair	
STPGS-2	Ground Sleeves (STP-200)	24"L	12 lbs	\$105 pair	

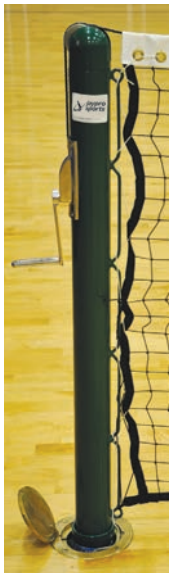

3" Deluxe Indoor Tennis Posts

Ideal for use with existing 10" deep floor sleeves at standard volleyball distance of 36 feet.

- > 3" OD round posts
- > 11 gauge steel construction
- > Solid stainless steel internal worm gear winch with self-locking mechanism to prevent recoiling during winding
- > Removable winch handle
- > 36' long net included

See page 14 for Floor Sleeves (PVB-70S or PVB-70S-CP)

ITS-300	46 lbs	\$489 pair	
----------------	--------	------------	---



3 1/2" Heavy-Duty Tennis Posts

- > 3 1/2" OD heavy-walled round steel posts
- > Steel top pulley caps with 1 3/4" dia aluminum pulley
- > Tensioning ratchet with spring-loaded safety latch
- > Removable handle
- > Assembly hardware included
- > Nets (TTN-3, TPL-5, CCPTN42) sold separately
- > Ground sleeves (TP-150G) for semi-permanent installation sold separately

TP-125	90 lbs	\$389 pair	
---------------	--------	------------	---

3 1/2" Galvanized Steel Tennis Posts

- > Same product as TP-125 except with galvanized finish

TPGS-35	68 lbs	\$369 pair	
----------------	--------	------------	---

3 1/2" Ground Sleeves

TP-150G	12 lbs	\$149 pair	
----------------	--------	------------	---

Pickleball







Deluxe Pickleball Posts



- > 54" tall 2 7/8" OD heavy-walled steel pipe
- > Heavy-duty self-locking winch with removable handle
- > Low profile die cast top cap
- > Adjustable height stop
- > Available for semi-permanent installation
- > 2 powder coat colors with zinc undercoat available
- > Ground sleeves with caps and net sold separately



RT-10BLK

PPR10BK	Black Post	\$339 pair	
PPR10GR	Green Post	\$339 pair	
TP-278G	Ground Sleeves & Covers	\$129 pair	
RT-10GR	Green Ratchet Reel	\$75 each	
RT-10BLK	Black Ratchet Reel	\$75 each	



Tournament Tennis Net



- > 3mm braided black polyethylene net
- > Top 5 rows double meshed
- > Quadruple stitched heavy-duty polyester headband
- > 3/16" dia vinyl coated steel cable
- > Synthetic taped bottom edges and side pockets with dowels
- > Dimensions: 42'L x 42"H

TTN-3 25 lbs \$229 each **1Y**

Collegiate Tennis Net

- > 2.5mm twisted black polyethylene net
- > Top 5 rows double meshed
- > Quadruple stitched heavy-duty polyester headband
- > 1/8" dia vinyl coated steel cable
- > Synthetic taped side and bottom edges
- > Dimensions: 42'L x 42"H

TPL-5 18 lbs \$169 each **1Y**

Country Club Tennis Net

- > 3.6mm braided black polyethylene net
- > 38 oz reinforced vinyl headband
- > Heavy-duty vinyl coated side and bottom taped
- > Side pockets with dowels
- > Dimensions: 42'L x 42"H

CCPTN42 22 lbs \$199 each **1Y**

Economy Tennis Net

Ideal for use with portable standards.

- > Lightweight and weather-resistant
- > #336 knotless nylon net with 1½" sq mesh
- > 2" vinyl headband with ¼" dia nylon cord cable
- > Taped side and bottom edges
- > Dimensions: 42'L x 42"H

TDP-42 7 lbs \$149 each **1Y**

Tennis Net

- > Use with volleyball systems
- > Dimensions: 36'L x 42"H

TPV-13 6 lbs \$189 each **1Y**

4' Courtside Tennis Bench



- > 10" wide non-skid aluminum seat planks
- > 2" x 2" heavy-duty galvanized steel legs are rust resistant
- > Floor protection kit (PSS-4FT) sold separately

PB40PC Powdercoated
50 lbs \$329 each **3Y**

PB40 Natural Finish
50 lbs \$259 each **3Y**

RolDri® Sponge Roller

Ideal for removing water from court.



- > 36" wide seamless tennis court roller
- > Durable polyvinyl alcohol construction
- > Non-deteriorating foam molded directly to roller core for seamless fit to ensure rapid streak free drying

TCSR Roller 8 lbs \$79 each **1Y**

TCSR-RR Replacement Sponge
2 lbs \$45 each **1Y**

Ratchet Reel (for TP-125)



- > Heavy-duty ratchet reel fits existing posts
- > Removable galvanized steel handle
- > Safety latch to prevent fly-away

RT-5GR 5 lbs \$75 each **3Y**

RT-5BK 5 lbs \$75 each **3Y**

Top Cap (for TP-125)



- > Fits 3½" OD post
- > 1¾" pulley sheave and set screws included

CAP-35 3 lbs \$22 each **3Y**

Center Strap

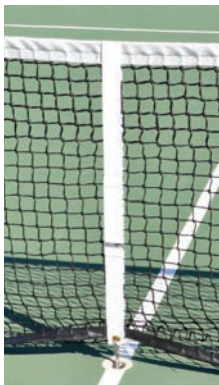

- > 2" adjustable nylon webbing
- > Double snap hook

CS-1 2 lbs \$12 each **1Y**

Center Strap Anchor

- > All aluminum construction
- > Stainless steel drive pin for easy snap assembly

A-2 2 lbs \$38 each **3Y**

Classic Wind Screen

Meet privacy and wind control needs with an attractive and economical wind screen. Customizable and ideal for tennis, baseball and other outside sports. *See page 72 for details about this product.*

TWS-6 6' Height \$0.71 sq ft **FR 1Y**

TWS-9 9' Height \$0.73 sq ft **FR 1Y**

Armor Mesh Wind Screen

Meet privacy and wind control needs with an attractive wind screen. Customizable and ideal for tennis, baseball and other outside sports. *See page 72 for details about this product.*

WSCRN-6 6' Height \$0.89 sq ft **FR 1Y**

WSCRN-9 9' Height \$0.99 sq ft **FR 1Y**



Little Champ™ Backboard Adapter

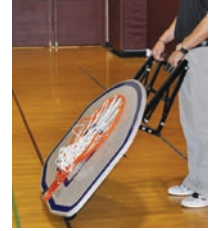

Little Champ™ Easy Adjust Backboard Adapter

Ideal for youth leagues and elementary schools to develop shooting skills.

- > Complete unit with fan-shaped backboard, lightweight attachment frame, official size goal and nylon net ships partially assembled
- > Easily installs from floor by one person
- > Safely attaches to any goal and 42" rectangular backboard (with or without edge padding)*
- > Adjust height without disassembly - 6½' to 9' - from floor
- > Moves backboard 2' closer to foul line

- > Adjustable frame overcomes sagging rims
- > Cannot be dislodged during play
- > No structure extends below backboard for safety
- > Dual wheels for convenient transport
- > Compact storage with hinging goal and aluminum folding rim

LC-6HP	49 lbs	\$729 each	
LC-6	98 lbs	\$1,349 pair	

* LC Arm Adapter Kit



Backboards greater than 42" tall may require this kit. Kit is required if measurement from top of rim to bottom of backboard is greater than 8".

LC-AKIT	8 lbs	\$249 each	
----------------	-------	------------	---



Little Champ™ 8.5 Backboard Adapter

- > Complete unit with fan-shaped backboard, lightweight attachment frame, official size goal and nylon net
- > Safely attaches to any goal and 42" rectangular backboard (with or without edge padding)*
- > Convert existing backboard to 8'6" youth regulation height
- > Adjustment hinge on frame to ensure backboard is always plumb
- > Compact storage with hinging frame and folding rim

LC-2HP	38 lbs	\$549 each	
LC-2	76 lbs	\$1,029 pair	

* LC Arm Adapter Kit



Backboards greater than 42" tall may require this kit. Kit is required if measurement from top of rim to bottom of backboard is greater than 8".

LC-AKIT	8 lbs	\$249 each	
----------------	-------	------------	---



Little Champ™ Classic Backboard Adapter

- > Complete unit with fan-shaped backboard, lightweight aluminum frame, official size goal and nylon net
- > Convert regulation height courts to 8'6" youth regulation height
- > Moves backboard 2' closer to foul line
- > Hand knobs secure unit to existing goal
- > Diagonal support adds strength and rigidity

LC-1HP	46 lbs	\$449 each	
LC-1	92 lbs	\$849 pair	

Little Champ™ Replacement Backboard

FSGB-1	20 lbs	\$224 each	
---------------	--------	------------	---



GymGlide™ a jaypro sports product



GymGlide™ Recreational Game Standard

- > Never tip to move or store
- > 155 lb base with holding capacity equivalent to 220 lb game standard
- > Telescoping upright includes lever-released composite height adjustment collars
- > Cast-iron base rides on retractable front swivel wheels
- > See chart for cast-iron base powder coat colors

GGG-100RB	ROYAL BLUE	170 lbs	\$598 each
GGG-100DG	DARK GREEN	170 lbs	\$598 each
GGG-100YW	YELLOW	170 lbs	\$598 each
GGG-100RD	RED	170 lbs	\$598 each
GGG-100W	WHITE	170 lbs	\$598 each



Engage wheels



Slide down telescopic upright and roll to storage





GymGlide™ Package #1

- > 2 GymGlide™ Game Standards (GGG-100XX)
- > 2 GymGlide™ Economy Upright Pads (GG-UPAD)
- > 1 Volleyball Net (VBN-32)

GGG-100PKG
(specify colors when ordering)
348 lbs \$1,275 package

FR 3Y 1Y X AS



GymGlide™ Package #2

- > 2 GymGlide™ Game Standards (GGG-100XX)
- > 2 GymGlide™ Base Pads (GG-BPAD)
- > 2 Official Standard Pads (PVB60PHP)
- > 1 Volleyball Net (VBN-32)

GGG-100PKGDG
(specify colors when ordering)
372 lbs \$2,119 package

FR 3Y 1Y X AS

GymGlide™ Padding

GymGlide™ Economy Upright Pad

- > Designed for GymGlide™ uprights
- > 2" thick foam pads are pre-slit for easy installation
- > Delivers as 8' section – can be cut in field
- > Available in the color safety yellow

GG-UPAD 5 lbs \$59 each 3Y

Official Standard Pad

- > 2" thick foam pad covered with vinyl
- > Hook-and-loop attachment
- > See chart for vinyl colors (specify when ordering)

PVB60PHP 9 lbs \$280 each 3Y

GymGlide™ Base Pad

- > Designed for GymGlide™ game standards
- > 2" thick foam pad covered with vinyl
- > See chart for vinyl colors (specify when ordering)

GG-BPAD 5 lbs \$399 each 3Y



Game Standards

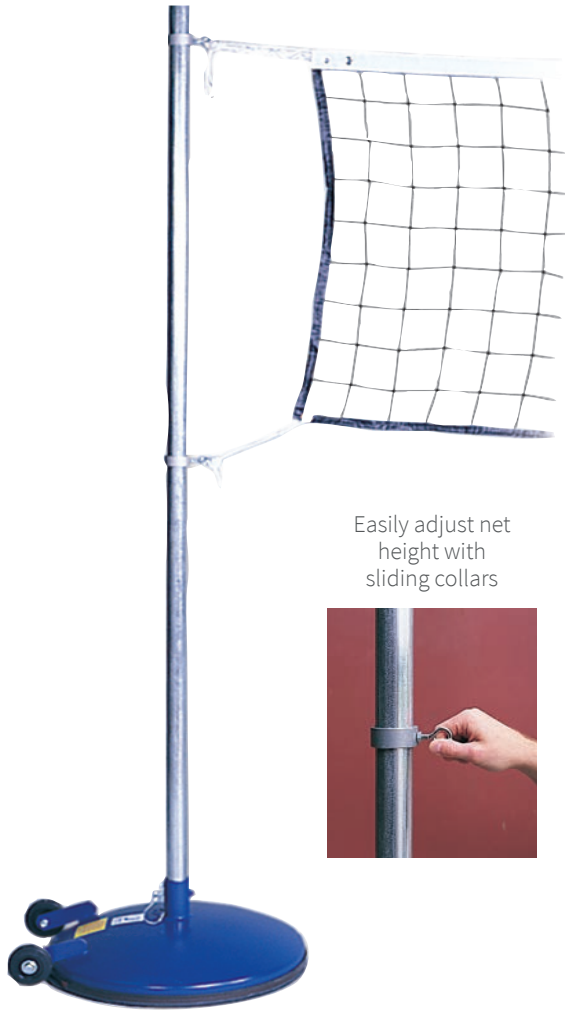

Easily adjust net height with sliding collars



Multi-Purpose Game Standard

- > Quick set-up
- > 24" dia steel bases available in 3 sizes
- > 2" dia uprights are 10' tall (two piece)
- > Exclusive safety hub with tethered safety bolt and 2 stabilizer jacking screws for an extra margin of safety
- > Rubber rims on base protect floor
- > 4" non-marking wheels for easy transport
- > Sliding eye bolt collars allow for net height adjustment

FR 3Y

Item #	Size in lbs	Color	Weight	Price
AS-475R	75	ROYAL BLUE	203 lbs	\$629 pair
AS-475RR	75	RED	203 lbs	\$629 pair
MP-500R	145	ROYAL BLUE	333 lbs	\$798 pair
MP-500RG	145	GREEN	333 lbs	\$798 pair
MP-500RR	145	RED	333 lbs	\$798 pair
MP-500RW	145	WHITE	333 lbs	\$798 pair
MP-500RY	145	YELLOW	333 lbs	\$798 pair
MPC-5145R*	145	ROYAL BLUE	167 lbs	\$425 each
MP-521R	220	ROYAL BLUE	487 lbs	\$998 pair
MP-521RR	220	RED	487 lbs	\$998 pair
MPC-5211R*	220	ROYAL BLUE	244 lbs	\$525 each

* Center pole allows for a 2 court setup

IMPORTANT SAFETY NOTICE

Game standards are heavy pieces of gymnasium equipment and require proper set-up, handling and maintenance by only trained supervisory personnel.



Base Pad

- > Designed for 24" dia portable bases
- > 2" thick pad covered with vinyl

PBC-24RD	RED	6 lbs	\$149 each	3Y
PBC-24RB	ROYAL BLUE	6 lbs	\$149 each	3Y



Economy Tennis Standards

- > Indoor/outdoor use
- > 2" OD galvanized steel standards are 44" tall
- > (2) 145 lb rubber mounted roll-a-way bases

JT-175R 314 lbs
\$779 pair 3Y

Economy Tennis Net

Ideal for use with Jaypro Sports portable standards.

- > Lightweight construction
- > #36 black weather-resistant knotless nylon net with 1 1/2" sq mesh
- > 2" wide white vinyl headband with black taped side and bottom edges
- > 1/4" dia nylon cord
- > Dimensions: 42'L x 39"H

TDP-42 7 lbs
\$149 each 1Y

Easy Play Game Standard

Ideal for volleyball, badminton, tennis, basketball rims and other games.

- > 6 $\frac{5}{8}$ " dia steel base is filled with 105 lbs of customer supplied ballast
- > 2" OD galvanized steel upright is 10' tall (two piece)
- > 6" non-marking wheels
- > Sliding eye bolt collars allow for net height adjustment
- > Weight never leaves the floor during transport
- > Net and other accessories sold separately
- > Dimensions: 40"W x 32"D

EZ-55HP 79 lbs \$289 each



Net Ball Adapter

- > Fits any 2" OD game standard upright
- > Goal, net and mounting hardware included

EZNB-10 15 lbs \$129 each



Elementary Basketball Adapter

- > Indoor use only
- > Fits any 2" OD game standard upright
- > 7' maximum goal height for safety
- > Goal, net and mounting frame included

EZBB-8 46 lbs \$389 each



EZBN-10



EZBB-8

Deluxe Game Standards

- > 2 $\frac{3}{8}$ " OD galvanized steel uprights with net tensioning ratchet is 8' tall
- > 24" dia steel base includes hand knob and guy wire for firm anchoring
- > 4" wheels
- > 2 floor anchors required and sold separately

SS-320R 142 lbs \$719 pair



Deluxe Center Standard

- > Single upright
- > Use with the Deluxe Game Standard (SS-320R) for a two court set-up
- > 2 floor anchors required and sold separately

SSC-321R 75 lbs \$429 each



Volleyball Net

VBN-32 4 lbs
Rope Cable - 36"W x 32'L
\$92 each



Badminton Net

BND-1 7 lbs
Lightweight Rope Cable - 30"W x 21'L
\$52 each



Tennis Net

TDP-42 7 lbs
Lightweight Rope Cable - 39"W x 42'L
\$149 each



Tetherball

Semi-Permanent Outdoor Tetherball Pole

- > 2" OD galvanized steel upright
- > 18" long aluminum ground sleeves with cast aluminum top cap for semi-permanent installation
- > Tetherball (TBP-BALL) sold separately
- > Installed Pole Height: 8 $\frac{1}{2}$ '

TBP-200 18 lbs \$169 each



Portable Tetherball Pole

- > Indoor/outdoor use
- > 2" OD galvanized steel upright is 10' tall
- > 12" long pre-assembled leader chain
- > 24" dia steel base with protective rubber trim weighs 75 lbs
- > 2 non-marking wheels
- > Tetherball (TBP-BALL) sold separately

TBP-275R 100 lbs \$399 each



Heavy-Duty Permanent Tetherball Pole

- > 2 $\frac{3}{8}$ " OD galvanized steel pole with cap and leader chain
- > Tetherball (TBP-BALL) sold separately

TBP-250 38 lbs \$199 each



Tetherball

- > Ultra-cushioned, sponge rubber construction in yellow
- > Recessed rope holder and nylon rope included

TBP-BALL 3 lbs \$20 each





Deluxe Floor Hockey Goal

- > Lightweight
- > 1 5/16" OD galvanized steel frame with cast aluminum corner fittings
- > Mounted rubber feet protect gymnasium floor
- > Durable polyethylene net with 1 3/4" sq mesh have colored sleeve-type binding (1 red and 1 blue)
- > Dimensions: 6'W x 4'H x 20"D

FHGN-33 73 lbs \$794 pair **3Y**

Replacement Nets

- > Replacement nets for Deluxe Floor Hockey Goals (FHGN-33)
- > 1 3/4" sq mesh and constructed of extra durable, twisted polyester
- > Colored sleeve-type binding (1 red and 1 blue)

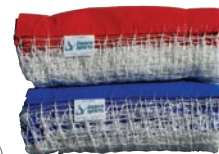

FHN-36 5 lbs \$159 pair **1Y**



Folding Multi-Purpose Goal

Ideal for quick games in the gym, street or driveway.

- > 1 5/16" OD steel frame
- > Rolls easily on non-marking wheels and folds flat for storage
- > Durable knotless nylon net with colored sleeve-type binding (1 red and 1 blue)
- > Hook-and-loop-closure
- > Dimensions: 6'W x 4'H



FHG-46PR Goals 39 lbs \$399 pair **3Y**

FHG-46N Red Net 5 lbs \$85 each **1Y**

STG-46N Blue Net 5 lbs \$85 each **1Y**



Archery Target Stand

- > Silver steel storage stand
- > Adjustable for 24"-48" targets
- > Includes wheels for easy transport
- > Target not included

PE-120 11 lbs \$74 each **3Y**



Archery Tripod Target Stand

- > Indoor/outdoor use
- > Silver steel storage stand
- > Adjustable for 24"-48" targets
- > Folds to tripod position
- > Cushioned footing
- > Target not included

PE-121 10 lbs \$54 each **3Y**



Throw Down Bases

- > Indoor/outdoor use
- > 3 bases, 1 home plate and 1 pitching rubber

BB-50 5 lbs \$16 set **3Y**



Torso Flexibility Box

- > Durable steel construction with foot rest plate
- > Accurately measures in inches and centimeters
- > Dimensions: 12"W x 20"L x 12"H

PE-FLXBX 13 lbs \$149 each **3Y**





Jump Rope Rack

- > 27" long wall-mounted all steel construction
- > Features five 10" long pegs for storage
- > Powder coated black

PE-110 7 lbs \$45 each 3Y



Racquet Stand

- > Portable steel stand
- > 3" x 5" wire mesh grid for holding racquets
- > Dimensions: 12"W x 30"L x 28"H

PE-RCSTND \$65 each 3Y

Germninja™

The Germninja™ Ultraviolet Sports Ball Sanitizer is your team's defense against bacteria and germs that cause contagious infections.

- > Kills germs that can cause strep, staph, H1N1, E.coli, Salmonella, MRSA, Influenza, Whooping Cough and other contagious infections
- > Unique design allows balls to roll past sanitizing light to ensure every nook and cranny is disinfected
- > Safe for all sports balls and leaves no residue build-up behind
- > Chemical free nontoxic technology made in the USA

GNJA1 150 lbs \$1,995 each 3Y



Germninja™ Liner

- > A specially woven silver embedded fabric with natural antimicrobial properties
- > Made with Argent 47 to naturally deprive bacteria of the food source needed to reproduce and survive

TENINJA-SPLIT Half Liner \$289 each 3Y

TENINJA-CART Full Liner \$389 each 3Y



Ball Storage	116-119
ToteMaster Storage Carts	116-118
Ball Carriers	118-119
Baseball/Softball	56-75
Batting Cages	56-58
Backstops & Padding	59
Batting Tunnels	60-63
Foul Poles	64-65
Protector Screens	66-67
Bases & Plates	68-70
Field Covers, Fence & Rail	72-73
Field Maintenance	74-75
Basketball	82-93
Outdoor Units	82-87
Backboards	88-89
Goals	90-91
Edge Padding	92
Benches & Bleachers	120-129
Player Benches	120-121
Tip & Roll Bleachers	122-123
Outdoor Bleachers	124-129
Field Hockey	55
Field Marking	76-79
Field Netting	110-115
Portable or Permanent Netting	110-111
FieldPro Custom Netting	112-115
Football	44-51
Goal Posts & Accessories	44-48
Football Storage Equipment	49
Football Training Equipment	50-51
Gymnasium	94-109
Indoor Portable Systems	94-95
Wall Mounted Backstops	96-98
Height Adjusters	99
Divider Curtains	104
Wrestling Mat Storage	105
WallGuard Wall Padding	106-109
Lacrosse	52-54
National Lacrosse League Goal	52
Box & Official Goals	53
Lacrosse Nets & Accessories	54
Physical Education	132-137
Little Champ Backboard Adapter	132
GymGlide Game Standard	133
Multi-Purpose Game Standards	134-135
Tetherball	135
Floor Hockey Goals, Archery Stands	136
Torso Flexibility Box	136
germninja	137
Soccerboards	80
Soccer	20-43
Official Goals	22-26
Training Goals & Rebounders	27
Club Goals	28-29
Futsal Goals	30
Indoor/Outdoor/Practice/Youth	31-33
Goal Anchors	34-35
Soccer Nets & Attachment	36-37
Field Accessories	38-39
Soccer Shelters	40-41
Combo Goals	42-43
Sports Training	81
Tennis	130-131
Tennis Posts	130
Pickleball	130
Tennis Nets & Accessories	131
Volleyball	4-19
Volleyball Systems	4-9
Volleyball Nets & Accessories	10-11
Referee Stands	12-13
Equipment Carriers	13
Floor Sleeves & Anchors	14-15
Volleyball Ball Carts	16
Overhead Volleyball	17
Training Equipment	18
Outdoor Volleyball	19

Terms & Conditions

Contact your local Jaypro Representative or Jaypro for detailed Information on Terms & Conditions

Returns: Jaypro will accept the authorized return of all standard products for any reason within 30 days of the ship date. **SPECIAL ORDER/ CUSTOM COLOR ITEMS ARE NOT RETURNABLE.** Customers must obtain a return authorization number from Jaypro after supplying the invoice number, item number, and reason for return. Customer is responsible for a 20% restocking fee and return freight charges.

Freight Damages & Discrepancies: Damages or shortages must be reported within 7 days of the delivery date. It is the responsibility of the customer to sign the delivery receipt as damaged or short. If Jaypro is notified within this time frame, we will replace as needed and file the claim with the carrier.

Payment Terms: We accept checks, American Express, Discover, MasterCard, and Visa. Approved accounts are required to submit a purchase order and will be billed Net 30 from the invoice date. All past due accounts are subject to a 1.5% per month (18% per year) interest charge and collection costs. Any approved account choosing to pay by credit card after the invoice date may be subject to a 3% credit card processing fee.

We reserve the right to correct typographical errors. Visit www.jaypro.com for a full list of Terms & Conditions.

MS2017A



Contact your local Jaypro Dealer:



Manufactured in Waterford, CT since 1953

BEN SHAFFER RECREATION Inc.
Serving NJ since 1921



PARK, PLAYGROUND & STREETScape SOLUTIONS

1-800-953-2021

www.benshaffer.com

sales@benshaffer.com

DREAM * DESIGN * DELIVER

PRESORTED STD
U.S. Postage Paid
Bolingbrook, IL
Permit No. 648

Jaypro Sports LLC © 2017

Sports Equipment and Athletic Facility/Field Solutions • www.jaypro.com



Providing a Complete Line of Equipment for your Sporting Needs:

Benches and Bleachers • Portable Backstops • Field Maintenance and Protection
Foul Poles • Official & Club Soccer Goals • Youth Training/Practice Goals • Wall Pads
Soccer Training Aids • Combo Goals • Football Goal Posts • Volleyball Net Systems
Referee Stands • Lacrosse and Field Hockey Goals • Storage Carts • Ball Carriers
Outdoor and Indoor Basketball Systems • Basketball Backboards, Rims and Nets
Field Marking • Game Standards • Tennis Posts and Nets • Windscreens • Field Netting

Contact your Jaypro Sports Representative today!